



Rinnai Gas Fire Ordering Guide **650 & 750/950 & 1250/SS850/LS Series**

Contents

Rinnai 650 & 750 Gas Fire Options

Step 1. Select model and gas type	3
Step 2. Select fascia option and colour	3
Step 3. Select burn media option	4
Step 4. Extras	4
Step 5. Select flueing configuration & components	5

Rinnai SS850 Gas Fire Options

Step 1. Select gas type	6
Step 2. Select fascia option and colour	6
Step 3. Select extras - optional	7
Step 4. Flue kit selection	7
Step 5. Select mandatory flue components	8
Step 6. Flueing components	8 - 9

Rinnai 950 & 1250 Gas Fire Options

Product overview	10
Step 1. Select engine, fascia, burn media & gas type	11 - 12
Step 2. Extras	13
Step 3. Flue installation configuration	14 - 15

Rinnai LS Series Gas Fire Options

Step 1. Select engine type	16
Step 2. Select flue kits	16
Step 3. Select flue components	17
Step 4. Select extras - optional	17

Rinnai 650 & 750 Selection Guide

Step 1. Select model and gas type

Model	Gas Type	Code	Dimensions	Output - kW	Input - mj/h
Rinnai 650 [includes remote]	Natural Gas	650ENGN	654H x 640W mm	5	23
	LPG	650ENGL			
Rinnai 750 [includes remote]	Natural Gas	750ENGN	654H x 750W mm	6	27
	LPG	750ENGL			



Rinnai 650 Gas Fire



Rinnai 750 Gas Fire

Step 2. Select fascia option and colour

FASCIA DESCRIPTION	650 CODE	750 CODE
3 Sided – Black	650F31P	750F31P
3 Sided – Titanium Grey	650F32	750F32
4 Sided – Black	650F41P	750F41P
4 Sided – Titanium Grey	650F42	750F42
3 Sided – Masonry Black XL (660 H x 825 W mm)	-	750F41XLP



3 sided frame is suitable for masonry applications or where the appliance sits directly at floor level.

4 sided frame is suitable for timber frame applications where the appliance is raised off the floor.

The XL masonry frame is suitable for masonry applications where the fireplace cavity requires a larger frame – this is available in 3 sided and black only.

Rinnai 650 & 750 Selection Guide

Step 3. Select burn media option

Model	Gas Type	Code
Rinnai 650	Glow Stones	650M1
	Natural Wood Log Set	650M2
Rinnai 750	Glow Stones	750M1
	Natural Wood Log Set	750M2



Glow Stones



Natural Wood Log Set

Step 4. Extras

Description	Suits	CODE
Zero clearance frame kit—used for ALL timber frame applications	650 & 750 (Common part)	650750ZCK
In-fill panels - for oversize masonry chimney cavities. Black only	650—700mm wide x 700 high	650IFP
	750—800mm wide x 700 high	750IFP
Gas fire Wi-Fi module	650 & 750	GFFWIFIMOD
Telescopic flue	275 - 375mm Adjustable Flue Length	RDV911
Weatherproof box—for external wall applications	650 & 750 (Common part)	650750WPB



Zero clearance frame kit

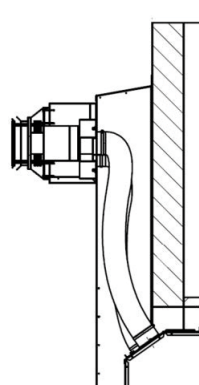

Weatherproof box



Gas Fire Wi-Fi Module

Rinnai 650 & 750 Selection Guide

Step 5. Select flueing configuration & components

Unit	Description	Code
Masonry Chimney: Twin pipe flexible flue kit. Suitable for masonry applications	Total flue kit includes: aluminium co-linear roof cowl DV, chimney plate, intake flexi, exhaust flexi, two of 75mm flue clamps and two of 100mm flue clamps 5.5m length	850FLEX
	Flue Kit 2.5m - Extension Kit Co-Linear Flexi. Optional - if more flue length required (masonry installation only)	850CLFLEX

Unit	Description	Code
Masonry Horizontal: Ideal for applications where the flue cannot terminate vertically. Masonry only –this flue configuration is not suitable for combustible applications.	Flexible pipes and co-linear to co-axial adaptor. Stretches out to 1.2m.	RDVFA
	Horizontal flue spigot	RDVHFS
	Horizontal terminal	RDV984

Unit	Description	Code
Vertical Flue: Timber frame applications	Co-linear to co-axial adaptor — includes 2 x flexi pipes, plate and transition piece. Stretches out to 1.2m.	RDVFA
	Select length co-axial pipe	See price list
	Vertical roof cowl	RDV991
	Zero clearance kit	650750ZCK

Unit	Description	Code
Horizontal Flue: Timber frame applications	Co-linear to co-axial adaptor — includes 2 x flexi pipes, plate and transition piece. Stretches out to 1.2m.	RDVFA
	90 degree elbow	RDV990G
	Select length co-axial pipe	See price list
	Horizontal wall cap	RDV984
	Zero clearance kit	650750ZCK

Unit	Description	Code
Weatherproof Box	Co-linear to co-axial adaptor — includes 2 x flexi pipes, plate and transition piece. Stretches out to 1.2m.	RDVFA
	Horizontal flue spigot	RDVHFS
	Horizontal wall cap	RDV984
	Weatherproof box	650750WPB
	Zero clearance kit	650750ZCK

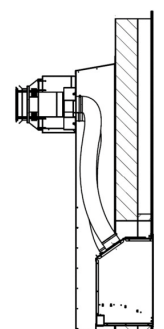
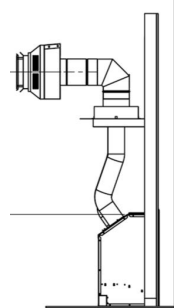
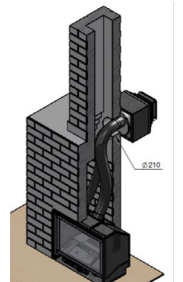
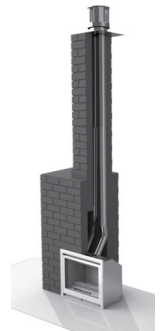

Rinnai 650 & 750 Selection Guide

Unit	Description	Code
Additional Flue Components	Pipe length 48 inch - (1200mm)	RDV902
	Pipe length 36 inch - (900mm)	RDV903
	Pipe length 24 inch - (600mm)	RDV904
	Pipe length 12 inch - (300mm)	RDV906
	Pipe length 9 inch - (230mm)	RDV907
	Adjustable Pipe Length 11 - 14 inch - (275 - 375mm)	RDV9117
	45° Elbow	RDV945G
	90° Elbow	RDV990G
	High Wind Terminal Cap (Vertical Cowl)	RDV991

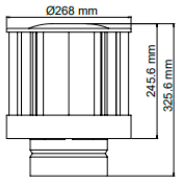

RDV991
High wind terminal cap
(vertical cowl)



RDV984
Horizontal terminal cap
Depth with horizontal flashing
kit installed-252 mm

Rinnai SS850 Selection Guide

Step 1. Select gas type

Model	Gas Type	Code	Dimensions	Output - kW	Input - mj/h
SS850 Built-In Co Axial in Timber	Natural Gas	SS850ICAN	660 H x 865 W mm	6.6	30
	LPG	SS850ICAL			
SS850 Built-In Co-Linear in Masonry	Natural Gas	SS850ICLN	660 H x 865 W mm	6.6	30
	LPG	SS850ICLL			
SS850 Freestanding	Natural Gas	SS850FCAN	660 H x 865 W mm	6.6	30
	LPG	SS850FCAL			



Rinnai SS850 Built-In Gas Fire



Rinnai SS850 Cabinet Gas Fire



Rinnai SS850FS Freestanding Gas Fire

Step 2. Select fascia option and colour

Model	Accessory	Code
SS850 Built-In Co Axial in Timber	Fascia Classic SS850 Bronze	SS850CFB
SS850 Built-In Co Linear in Masonry	Infill Panel SS850 Black	SS850IFP
	Fascia Classic SS850 Bronze	SS850CFB
SS850 Freestanding	SS850 Cabinet Base	SS850FSBC
	SS850 Plinth Base	SS850FSBP



Black

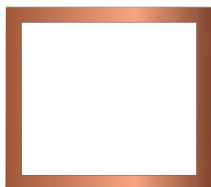

Bronze



Rinnai SS850 Cabinet Gas Fire



Rinnai SS850FS Freestanding Gas Fire

Rinnai SS850 Selection Guide

Step 3. Extras - optional

Model	Gas Type	Code
Rinnai SS850	Wi-Fi Kit	GFFWIFIMOD



Gas Fire Wi-Fi Module

Step 4. Flue Kit Selection

Model	Selected Flue Kits	Code
SS850 Built-In Co Axial in Timber	Flue Kit DV - 3.6m Vertical co-axial (Galvanised)	RDVSV
SS850 Built-In Co Linear in Masonry	Flue Kit Flexi - 5.5m Co-linear	850FLEX
	Flue Kit Flexi - 2.5m Extension co-linear	850CLFLEX
SS850 Freestanding	Flue Kit DV - 3.6m Vertical co-axial (Black)	RDVSVB



Flue Kit DV 3.6m
(Galvanised)

RDVSV



Flue Kit Flexi 5.5m

850FLEX



Flue Kit Flexi 2.5m

850CFLEX



Flue Kit Flexi 2.5m (Black)

RDVSVB

Rinnai SS850 Selection Guide

Step 5. Select Mandatory Flue Components

Model	Selected Flue Kits	Code
SS850 Built-in co-Axial in timber	Flue support for flues and elbows	RDV951
	High wind vertical cowl protection kit	RDB992
SS850 Built-in co-linear in masonry	High wind vertical cowl protection kit	RDB992
SS850 Freestanding	Flue support for flues and elbows	RDV951
	High wind vertical cowl protection kit	RDB992

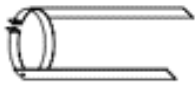

Flue support RDV951



Flue support RDB992

Step 6. Flueing Components

Unit	Description	Code
Rinnai SS850 Built-in co-axial	275 - 375mm Adjustable flue length	RDV911
	230mm Flue length	RDV907
	300mm Flue length	RDV906
	600mm Flue length	RDV904
	900mm Flue length	RDV903
	1200mm Flue length	RDV902
	45 Degree elbow	RDV945G
	45 Degree elbow x 2 - GAL	RDV945G2
	90 Degree elbow	RDV990G
	Wall strap DV	RDV954
	Coaxial vertical flue cowl	RDV991



275 - 375mm Adj. Flue Length



230 - 1200mm Flue Length

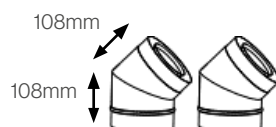

45 Degree Elbow



90 Degree Elbow



Wall Strap DV

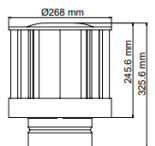

Coaxial Vertical Flue Cowl

Rinnai SS850 Selection Guide

Step 6. Flueing Components

Unit	Description	Code
Rinnai SS850 Freestanding	230mm Flue length - Black	RDV907B
	300mm Flue length - Black	RDV906B
	600mm Flue length - Black	RDV904B
	900mm Flue length - Black	RDV903B
	1200mm Flue length - Black	RDV902B
	360mm Flue extension - Black	RDV911B
	45 Degree elbow x 2 - Black	RDV945B
	90 Degree elbow - Black	RDV990B
	Flue DV ceiling plate 90 Degree	RDVCP90
	Flue DV ceiling plate 45 Degree	RDVCP45



230 - 1200mm Flue Length



360mm Flue Extension



45 Degree Elbow



90 Degree Elbow



Flue DV Ceiling Plate 90 Degree



Flue DV Ceiling Plate 45 Degree

Rinnai 950 & 1250 Selection Guide

Product overview

Model	Dimensions	Output - kW	Input - mj/h
Rinnai 950 [includes remote]	620H x 1020Wmm	8.0	34
Rinnai 1250 [includes remote]	620H x 1320Wmm	8.4	34



Rinnai 950 Gas Fire



Rinnai 1250 Gas Fire

Rinnai 950 Selection Guide

Step 1. Select Engine, Fascia, Burn Media & Gas Type

Model	Gas Type	Code
Black 952 Logset Engine Black fascia / logset media	Natural Gas	K952BN
	LPG	K952BL



Model	Gas Type	Code
Stainless 952 Logset Engine SS on black fascia / Logset media	Natural Gas	K952SN
	LPG	K952SL



Model	Gas Type	Code
Black 952 Ceramic Stones Engine Black fascia / Ceramic Stones Media	Natural Gas	K952BCN
	LPG	K952BCL



Model	Gas Type	Code
Stainless 952 Ceramic Stones Engine SS on Black fascia / Ceramic Stones Media	Natural Gas	K952SCN
	LPG	K952SCL



Rinnai 1250 Selection Guide

Step 1. Select Engine, Fascia, burn media & gas type

Model	Gas Type	Code
Black 1250 Logset Engine Black fascia / Logset media	Natural Gas	K1253BN
	LPG	K1253BL



Model	Gas Type	Code
Stainless 1250 Logset Engine SS on black fascia / Logset media	Natural Gas	K1253SN
	LPG	K1253SL



Model	Gas Type	Code
Black 1250 Ceramic Stones Engine Black fascia / Ceramic Stones Media	Natural Gas	K1253BCN
	LPG	K1253BCL



Model	Gas Type	Code
Stainless 1250 Ceramic Stones Engine SS on Black fascia / Ceramic Stones Media	Natural Gas	K1253SCN
	LPG	K1253SCL



Rinnai 950 & 1250 Selection Guide

Step 2. Extras

Description	CODE
Weatherproof Box Kit 950	950WPB
Weatherproof Box Kit 1250	1250WPB
Gas Fire Wi-Fi Module* 950/1250	GFFWIFIMOD
Reflective side panels 1250	1250REF1

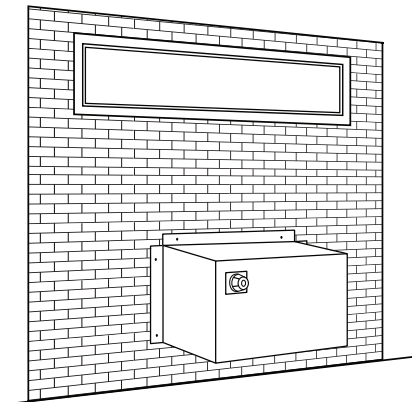

Weatherproof Box – External view.



Gas Fire Wi-Fi Module

Rinnai 950 & 1250 Selection Guide

Step 3. Flue Installation Configuration

Direct / Extended

Description	Component	CODE
Option A [Direct]	Direct Flue Kit Rinnai Flamefires	ASPDFK
Option B [Direct Extended]	Direct Flue Kit	ASPDFK
	# Co-Ax Pipe 900mm [Optional]	ESPIPE900

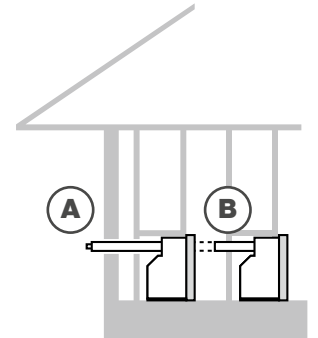

External Wall

Description	Component	CODE
Option A [Vertical Termination]	Direct Flue Kit Rinnai Flamefires	ASPDFK
	# Co-Ax Pipe 900mm	ESPIPE900
	45° Bend x 2	ESBEND
	Condensate Trap	ESCONDK
Option B [Wall Termination]	Roof Cowl	ESROOFCOWL
	Direct Flue Kit Rinnai Flamefires	ASPDFK
	# Co-Ax Pipe 900mm	ESPIPE900
	45° Bend x 2	ESBEND
	Condensate Trap	ESCONDK
	Wall Terminal Kit	ESWTKIT

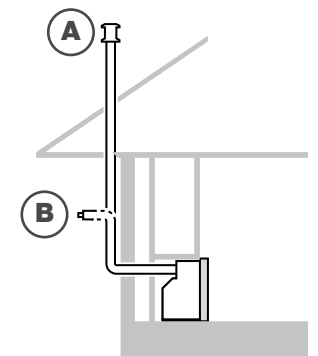

Internal Wall

Description	Component	CODE
Option A [Direct]	##Flue Adaption Kit Flamefires	ASPKIT03
	# Co-Ax Pipe 900mm	ESPIPE900
	Roof Cowl	ESROOFCOWL
Option B [Offset]	##Flue Adaption Kit Flamefires	ASPKIT03
	# Co-Ax Pipe 900mm	ESPIPE900
	45° Bend x 2	ESBEND
	Roof Cowl	ESROOFCOWL
Option C [Offset] GLFFKITIW Kit [Same configuration as option B, but with longer flue length]	##Flue Adaption Kit x 1 pce	ASPKIT03
	Co-Ax Pipe 900mm x 3 pces	ESPIPE900
	45° Bend x 2 pces	ESBEND
	Roof Cowl x 1 pce	ESROOFCOWL

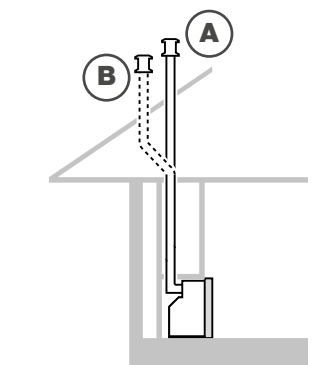

#Order lengths as required. ##Includes Condensate Trap [ESCONDK]

Rinnai 950 & 1250 Flue Components

ASPDFK

(Direct Flue Kit for Rinnai Flamefires)

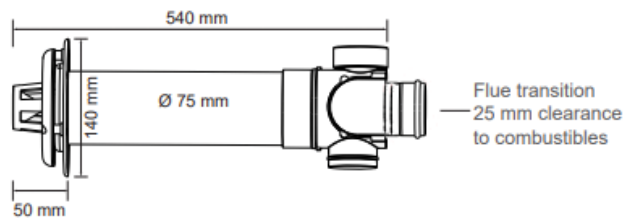
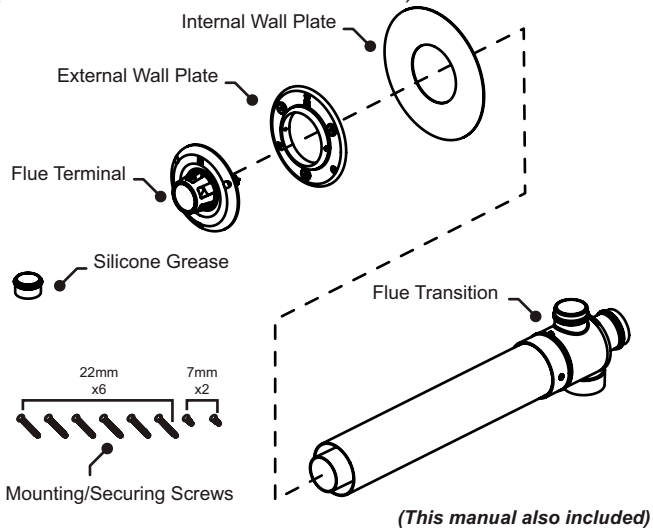

ASPKIT03

(Flue Adaption Kit
for Rinnai Flamefires)

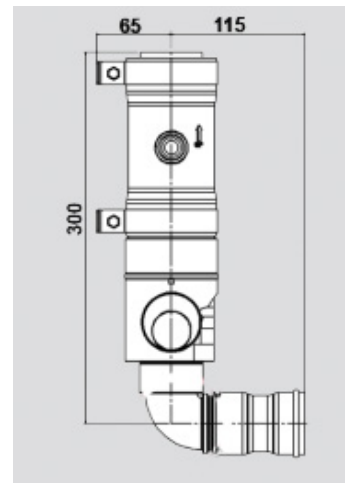
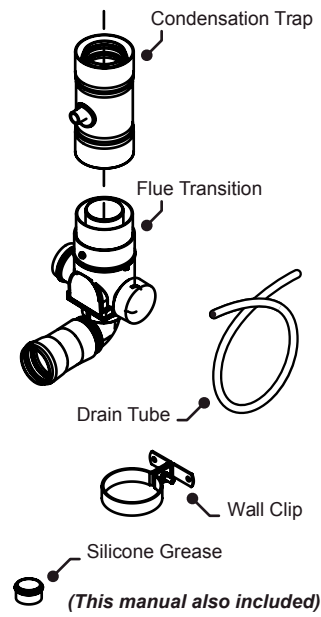

Rinnai 950 & 1250 Flue Components

GLFFKITIW

(Extended Flue Adaption
Kit for Rinnai Flamefires)

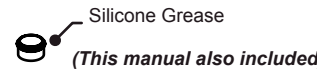
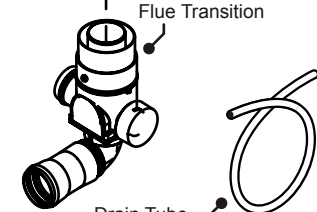
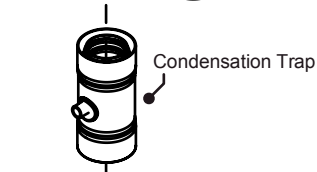
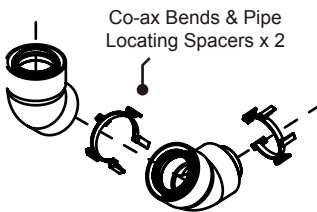
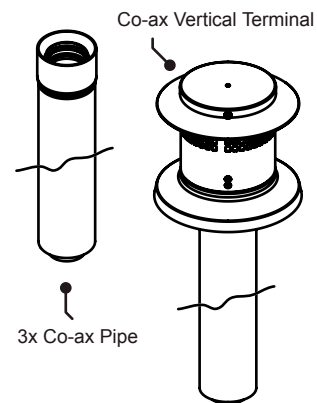

ESPIPE

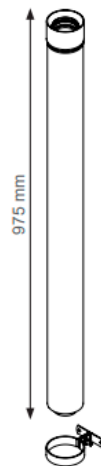

ESROOFCOWL

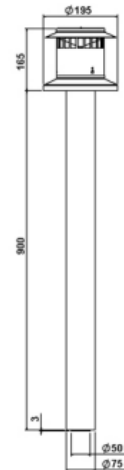

ESBEND

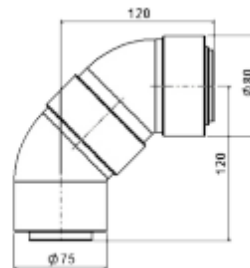

Rinnai 950 & 1250 Selection Guide

Step 3. Flue Installation Configuration

Sideways

Description	Component	CODE
Direct	##Flue Adaption Kit Flamefires	ASPKIT03
	# Co-Ax Pipe 900mm	ESPIPE900
	Terminal Kit	ESWTERM

Under Floor

Description	Component	CODE
Direct	##Flue Adaption Kit Flamefires	ASPKIT03
	# Co-Ax Pipe 900mm	ESPIPE900
	45° Bend x 2 pces	ESBEND
	Terminal Kit	ESWTERM

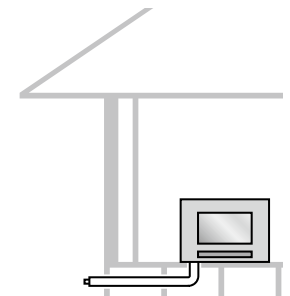
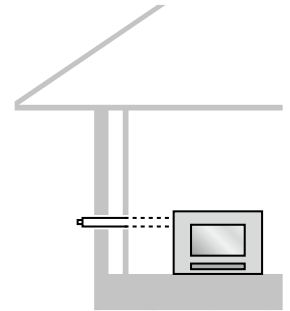

A maximum flue length of 8.5 metres is permissible provided there are no bends. Each 90° bend is equivalent to 1 metre of flue length. Therefore, the total flue length may be up to 6.5 metres with 2 x 90° bends. The ASPKIT03 Flue Adaptor contains one bend and this is counted as 1 x 90° bends.

LS Series Selection Guide

Step 1. Select engine type

Unit	Description	Code
LS800 + Log Set	LS800 FlameTech® single sided NG	LS800SFN
	LS800 FlameTech® single sided LPG	LS800SFL
	LS800 FlameTech® double sided NG	LS800DFN
	LS800 FlameTech® double sided LPG	LS800DFL
LS1000 + Log Set	LS1000 single sided NG + Log Set	KLS1000SN1
	LS1000 single sided LPG + Log Set	KLS1000SL1
	LS1000 double sided NG + Log Set	KLS1000DN1
	LS1000 double sided LPG + Log Set	KLS1000DL1
LS1000 + Burn Media	LS1000 single sided NG + Burn Media	KLS1000SN2
	LS1000 single sided LPG + Burn Media	KLS1000SL2
	LS1000 double sided NG + Burn Media	KLS1000DN2
	LS1000 double sided LPG + Burn Media	KLS1000DL2
LS1500 + Log Set	LS1500 single sided NG + Log Set	KLS1500SN1
	LS1500 single sided LPG + Log Set	KLS1500SL1
	LS1500 double sided NG + Log Set	KLS1500DN1
	LS1500 double sided LPG + Log Set	KLS1500DL1
LS1500 + Burn Media	LS1500 single sided NG + Burn Media	KLS1500SN2
	LS1500 single sided LPG + Burn Media	KLS1500SL2
	LS1500 double sided NG + Burn Media	KLS1500DN2
	LS1500 double sided LPG + Burn Media	KLS1500DL2

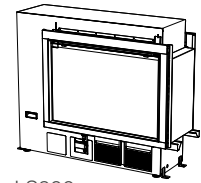

LS800

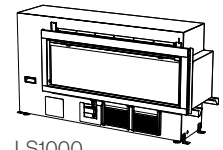

LS1000

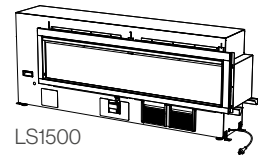

LS1500

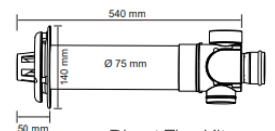

Direct Flue Kit
LSDFK01

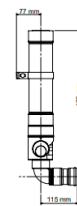

LS Flue Adaptor Kit
LSFKIT01



LS Extended Flue
Adaptor Kit
LSFKIT02
(Total length: 4m)

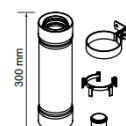

LS Flue Transition
Extension Kit
LSEXTKIT01

Step 2. Select flue kits and components (depending on the flue configuration)

Unit	Description	Code
LS Series	Direct Flue Kit	LSDFK01
	LS Flue Adaptor Kit	LSFKIT01
	LS Extended Flue Adaptor Kit	LSFKIT02
	LS Flue Transition Extension Kit	LSEXTKIT01

LS Series Selection Guide

Step 2. Select flue kits and components (depending on the flue configuration)

Unit	Description	Code
LS Series	Flue pipe 900mm	ESPIPE900
	Vertical flue terminal	ESROOFCOWL
	Bends (2 x 45°)	ESBEND
	Universal plate	ESPLATE
	Wall terminal kit	ESWTERM
	Flue guard	ESWFG
	Wall terminal kit 2	ESWTKIT2

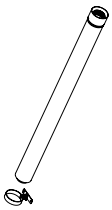

Flue pipe 900mm

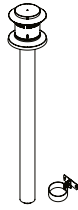

Vertical Flue Terminal

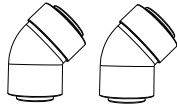

Bends (2 x 45°)



Universal plate



External wall plate

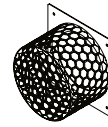

Flue guard

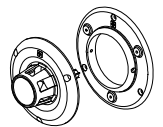

Wall terminal kit 2

Step 3. Select extras - optional

Unit	Description	Code
LS800	Peninsula pack LS800 L	LS800PENPCKL2
	LS800 wide trim 50mm	LS800WT50
	LS800 gas fire window kit	LS800DFWKIT
LS1000	Peninsula pack LS1000/LS1500	LS10001500PENPCKL2
	LS1000 wide trim 50mm	LS1000WT50
	LS1000 gas fire window kit	LS1000DWKIT
LS1500	Peninsula pack LS1000/LS1500	LS10001500PENPCKL2
	LS1500 wide trim 50mm	LS1500WT50
	LS1500 gas fire window kit	LS1500DWKIT



Peninsula pack



Wide trim

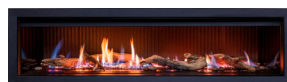

Window kit