

## MODELS

System	Indoor	Outdoor
HSNRP26B	HINRP26MB	HONRP26B
HSNRP35B	HINRP35MB	HONRP35B
HSNRP50B	HINRP50MB	HONRP50B
HSNRP60B	HINRP60MB	HONRP60B
HSNRP70B	HINRP70MB	HONRP70B
HSNRP80B	HINRP80B	HONRP80B
Ref Only	HINRP20MB	Matching Multi System Only

REFRIGERANT  
**R32**

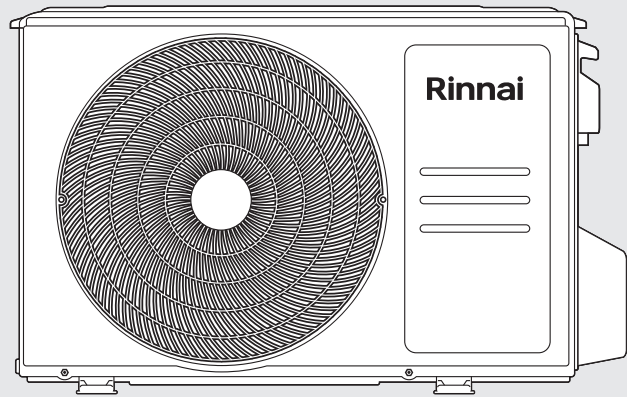
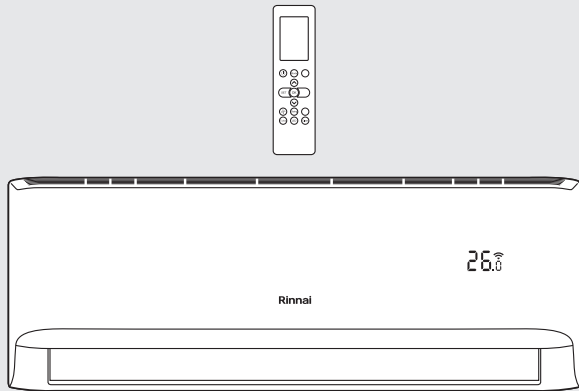

# PB Series Split Type Wall Mounted Air Conditioner Installation Manual

# Rinnai

This appliance must be installed in accordance with:

- Manufacturer's Installation Instructions
- Current AS/NZS 3000, AS/NZS 5141, AS/NZS 5149
- Local Regulations and Municipal Building Codes including local OH&S requirements

This appliance must be installed, maintained and removed only by an Authorised Person.

For continued safety of this appliance it must be installed and maintained in accordance with the manufacturer's instructions.



# TABLE OF CONTENTS

<b>Warnings and Important Information</b>	<b>4</b>
<b>Accessories</b>	<b>10</b>
<b>Installation Summary</b>	<b>11</b>
Indoor Unit .....	11
<b>Description</b>	<b>12</b>
<b>Indoor Installation</b>	<b>13</b>
Installation Instructions – Indoor Unit .....	13
<b>Outdoor Installation</b>	<b>19</b>
Installation Instructions – Outdoor Unit .....	19
<b>Refrigerant Piping Connection</b>	<b>23</b>
Note on Pipe Length .....	23
Connection Instructions – Refrigerant Piping .....	23
Instructions for Connecting Pipe to Outdoor Unit .....	25
<b>Air Evacuation</b>	<b>26</b>
Preparations and Precautions .....	26
Evacuation Instructions .....	26
Note on Adding Refrigerant .....	27
<b>Electrical and Gas Leak Checks</b>	<b>28</b>
Before Test Run .....	28
Electrical Safety Checks .....	28
<b>Test Run</b>	<b>29</b>
Test Run Checks .....	29
<b>Checklist</b>	<b>30</b>
<b>Specifications</b>	<b>31</b>
<b>Contacts</b>	<b>36</b>

# WARNINGS AND IMPORTANT INFORMATION



## READ ALL INSTRUCTIONS BEFORE USING THE APPLIANCE.

Always comply with the following precautions to avoid dangerous situations and to ensure optimum performance.

Failure to carefully read and follow all instructions in this manual can result in equipment malfunction, property damage, personal injury and/or death.

**DANGER:** Indicates an imminently hazardous situation which, if not avoided, will result in personal injury or death.

**WARNINGS:** Indicates a potentially hazardous situation which, if not avoided, could result in personal injury or death.

**CAUTIONS:** Indicates a potentially hazardous situation which, if not avoided, could result in minor or moderate injury or damage to the appliance. It may also be used to alert against unsafe practices.



## REGULATORY

This appliance shall be installed in accordance with:

Manufacturer's Installation Instructions.

Current AS/NZS 3000, AS/NZS 5141, AS/NZS 5149.

Local Regulations and Municipal Building Codes including local OH&S requirements.

This appliance must be installed, maintained and removed **ONLY** by an Authorised Person.

For continued safety of this appliance it must be installed and maintained in accordance with the manufacturers instructions.

This appliance uses R32 refrigerant.

This appliance is heavy, use 2 people or mechanical lifting device. Improper lifting may result in serious injury.

Take care when opening or unpacking this appliance. Failure to do so may result in serious injury or product failure.

**DO NOT** modify the electrical wiring of this appliance. If the control power wiring is damaged or deteriorated then it must be replaced by an authorised person. Failure to do so may result in electric shock, fire, serious injury or product failure.

**DO NOT** install the air conditioner on an unstable or non level surface or where there may be a danger of it falling. It may result in death, serious injury, or product failure.

**DO NOT** install the outdoor unit where noise may cause nuisance.

**DO NOT** install the outdoor unit where it will be exposed to sea wind (salt spray) as this will reduce durability.



## MANDATORY INSPECTION PRIOR TO INSTALLATION

Immediately report any damage or discrepancies to the Supplier of the appliance. This appliance was inspected and tested at the time of manufacture and packaging, and released for transportation without known damage. Upon receipt, inspect the exterior for evidence of rough handling in shipment. Ensure that the appliance is labelled correctly for the gas and electrical supply, and/or other services it is intended to be connected to.

For safety and warranty purposes, appliances that may be damaged or incorrect **MUST NOT** be installed or operated under any circumstances. Installation of damaged or incorrect appliances may contravene local government regulations. Rinnai disclaims any liability or responsibility whatsoever in relation to the installation or operation of damaged or incorrect appliances.



## INSTALLATION

This appliance shall be installed in accordance with local electrical safety regulations by an authorised person such as a licensed electrician. Contact an authorised service technician for repair or maintenance of this appliance.

Only use the included accessories, parts, and specified parts for installation. Using non-standard parts can cause water leakage, electrical shock, fire, and can cause the unit to fail.

Install the unit in a firm location that can support the unit's weight. If the chosen location cannot support the unit's weight, or the installation is not done properly, the unit may drop and cause serious injury and damage.

**DO NOT** turn on the power until all work has been completed.

When moving or relocating the air conditioner, consult experienced service technicians for disconnection and reinstallation of the unit.

How to install the appliance to its support, please read the information for details in "indoor unit installation" and "outdoor unit installation" sections.

For units that have an auxiliary electric heater, **DO NOT** install the unit within 1 meter (3 feet) of any combustible materials.

**DO NOT** install the unit in a location that may be exposed to combustible gas leaks. If combustible gas accumulates around the unit, it may cause fire.

Install drainage piping according to the instructions in this manual. Improper drainage may cause water damage to your home and property.

This appliance is a Type 1 Electrical Appliance.

Make sure the live wire, neutral wire and earth wire in the power socket are properly connected. Inadequate or incorrect electrical connections may cause fire or electric shock.

The yellow-green wire in air conditioner is the earthing wire which cannot be used for other purposes. Improper earthing may cause electric shock.

The circuit breaker must have the functions of magnetic tripping and heat tripping to prevent short circuit and overload.

Use a standard circuit breaker and fuse conforming with the rating of the appliances.

The unit must be earthed in accordance with local regulations.

Connect all wiring tightly. Failure to do so may result in electric shock or product failure.

**DO NOT** supply power to the unit until all wiring and tubing are completed.

Select an installation location where the components can be mounted securely and accessible for service and replacement.

Make sure tubing is properly insulated to ensure optimum performance.

Install the drain hose properly for smooth drainage of condensed water.

Make sure to check for and rectify any refrigerant leaks after you install or repair the unit.

This appliance uses R32 (difluoromethane) refrigerant, which is a flammable gas class 2.2 according to AS/NZS 1677 and must be handled by a refrigeration mechanic with appropriate Australian refrigerant handling licence.

## WARNINGS AND IMPORTANT INFORMATION



**WARNING** Risk of fire / flammable material. If the refrigerant is leaked, together with an external ignition source, there is a possibility of ignition.



Read the **OPERATING INSTRUCTIONS** carefully before operation.



Service personnel are required to carefully read the **OPERATING INSTRUCTIONS** and **INSTALLATION MANUAL** before operation.



Further information is available in the **OPERATING INSTRUCTIONS**, **INSTALLATION MANUAL**, and the like.

Certain levels of refrigerant require minimum room sizes. Please ensure that these minimum room sizes are adhered to for standard installations (up to 10m pipe length). If larger refrigerant charges than standard are used then please consult AS/NZS 60335.2.40 to determine the safe minimum floor area for the installation.

Make sure that the area has been made safe by having suitable ventilation and is free from ignition sources before charging or releasing the charge of R32.

Model	HSNRP26B	HSNRP35B	HSNRP50B	HSNRP60B	HSNRP70B	HSNRP80B
Standard Charge (g)	900	900	1260	1260	1400	1400
Minimum Floor Area (m <sup>2</sup> )	4.0	4.0	4.0	4.0	4.0	4.0



### WARNINGS FOR PRODUCT USE

If an abnormal situation arises (like a burning smell), immediately turn off the unit and disconnect the power. Call your dealer for instructions to avoid electric shock, fire or injury.

**DO NOT** insert fingers, rods or other objects into the air inlet or outlet. This may cause injury, since the fan may be rotating at high speeds.

**DO NOT** use flammable sprays such as hair spray, lacquer or paint near the unit. This may cause fire or combustion.

**DO NOT** operate the air conditioner in places near or around combustible gases. Emitted gas may collect around the unit and cause explosion.

**DO NOT** operate your air conditioner in a wet room such as a bathroom or laundry room. Too much exposure to water can cause electrical components to short circuit.

**DO NOT** expose your body directly to cool air for a prolonged period of time.

**DO NOT** allow children to play with the air conditioner. Children must be supervised around the unit at all times.

If the air conditioner is used together with burners or other heating devices, thoroughly ventilate the room to avoid oxygen deficiency.

In certain functional environments, such as kitchens, server rooms, etc., the use of specially designed air-conditioning units is highly recommended.



**OPERATION**

**DO NOT** let the air conditioner run for extended periods when the humidity is very high or when doors or windows are left open. As this may result in an excessive operational loading and lead to product failure.

**DO NOT** cover or place articles on any part of this appliance.

**DO NOT** touch, operate or clean the air conditioner with wet hands. It may result in electric shock or product failure.

**DO NOT** insert hands or other objects through the air inlet or outlet while the appliance is operating. It may result in electric shock or product failure.

**DO NOT** place a heater or other heating appliances near this appliance, always ensure sufficient ventilation when using this appliance and a heating appliance at the same time. Failure to do so may result in product mis-operation.

Turn main power off before cleaning. Failure to do so may result in fire, electric shock, or product failure.

**DO NOT** use solvents, abrasives or harsh detergent to clean any part or surface of this appliance or spray water or allow liquids to enter the indoor unit. The enclosure of the appliance and remote control can be cleaned using a soft, damp cloth and a mild detergent.

**NEVER** touch the metal parts of the air conditioner when you remove the air filter. It may result in electric shock or product failure.

**DO NOT** leave flammable materials near the appliance. It may result in explosion or fire.

If there is excessive noise, smell or smoke coming from the appliance, turn the appliance off, isolate the power supply and contact a service agent.

**DO NOT** operate the appliance if it has been submerged into water due to flooding, contact a service agent. Failure to do so may result in electric shock, fire, serious injury, or product failure.

This appliance is not intended for use by persons (including children) with reduced physical, sensory or mental capabilities, or lack of experience and knowledge unless they have been given supervision or instruction concerning use of the appliance by a person responsible for their safety.

Children should be supervised to ensure that they **DO NOT** play with the appliance.

The air conditioning system is designed to achieve consumer comfort. It is **NOT** designed for commercial applications requiring a controlled atmosphere (i.e. computer rooms, food preservation, etc.)

**DO NOT** block the inlet or outlet of air flow. It may result product in failure.

**DO NOT** drink the condensate water drained from the appliance. This condensate is not potable and may present a health risk if consumed.

**DO NOT** expose people, animals or plants directly to the cold or hot discharge of the appliance. It may result in serious injury.

**DO NOT** mix the batteries for the remote control with other types of batteries or mix new batteries with used batteries. Failure to do so may result in product failure. **STOP** using the remote control if there is a battery fluid leak.

**OPERATION RANGE LIMITATIONS**

The table below indicates the temperature ranges the air conditioner can be operated within.

MODE	Cool Mode	Heat Mode	Dry Mode
Room Temperature	> 16°C	< 30°C	> 16°C
Outdoor Temperature	0°C ~ 50°C	-15°C ~ 24°C	0°C ~ 50°C



### CLEANING AND MAINTENANCE WARNINGS

Turn off the device and disconnect the power before cleaning. Failure to do so can cause electrical shock.

**DO NOT** clean the air conditioner with excessive amounts of water.

**DO NOT** clean the air conditioner with combustible cleaning agents. Combustible cleaning agents can cause fire or deformation.



### OPERATING CAUTIONS

Turn off the air conditioner and disconnect the power if you are not going to use it for a long time.

Turn off and unplug the unit during storms.

Make sure that water condensation can drain unhindered from the unit.

**DO NOT** operate the air conditioner with wet hands. This may cause electric shock.

**DO NOT** use device for any other purpose than its intended use.

**DO NOT** climb onto or place objects on top of the outdoor unit.

**DO NOT** allow the air conditioner to operate for long periods of time with doors or windows open, or if the humidity is very high.



### ELECTRICAL WARNINGS

Only use the specified power cord. If the power cord is damaged, it must be replaced by the manufacturer, its service agent or similarly qualified persons in order to avoid a hazard.

Keep power plug clean. Remove any dust or grime that accumulates on or around the plug. Dirty plugs can cause fire or electric shock.

**DO NOT** pull power cord to unplug unit. Hold the plug firmly and pull it from the outlet. Pulling directly on the cord can damage it, which can lead to fire or electric shock.

**DO NOT** modify the length of the power supply cord or use an extension cord to power the unit.

**DO NOT** share the electrical outlet with other appliances. Improper or insufficient power supply can cause fire or electrical shock.

The product must be properly grounded at the time of installation, or electrical shock may occur.

For all electrical work, follow all local and national wiring standards, regulations, and the

Installation Manual. Connect cables tightly, and clamp them securely to prevent external forces from damaging the terminal. Improper electrical connections can overheat and cause fire, and may also cause shock. All electrical connections must be made according to the Electrical Connection

Diagram located on the panels of the indoor and outdoor units.

All wiring must be properly arranged to ensure that the control board cover can close properly. If the control board cover is not closed properly, it can lead to corrosion and cause the connection points on the terminal to heat up, catch fire, or cause electrical shock.

If connecting power to fixed wiring, an all-pole disconnection device which has at least 3mm clearances in all poles, and have a leakage current that may exceed 10mA, the residual current device (RCD) having a rated residual operating current not exceeding 30mA, and disconnection must be incorporated in the fixed wiring in accordance with the wiring rules.





### FUSE SPECIFICATIONS

The air conditioner's circuit board (PCB) is designed with a fuse to provide overcurrent protection.

The specifications of the fuse are printed on the circuit board ,such as:

T3.15AL/250VAC, T5AL/250VAC, T3.15A/250VAC, T5A/250VAC, T20A/250VAC, T30A/250VAC,etc.

**NOTE:** For the units using R32 refrigerant, only the blast-proof ceramic fuse can be used.



### FLUORINATED GASES

This air-conditioning unit contains fluorinated greenhouse gases. For specific information on the type of gas and the amount, please refer to the relevant label on the appliance itself or the "Operation Manual" in the packaging of the outdoor unit.

Installation, service, maintenance and repair of this unit must be performed by a certified technician.











Product uninstallation and recycling must be performed by a certified technician.

For equipment that contains fluorinated greenhouse gases in quantities of 5 tonnes of CO<sub>2</sub> equivalent or more, but of less than 50 tonnes of CO<sub>2</sub> equivalent, If the system has a leak detection system installed, it must be checked for leaks at least every 24 months.

When the unit is checked for leaks, proper record-keeping of all checks is strongly recommended.

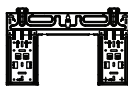
# ACCESSORIES

The air conditioning system comes with the following accessories. Use all of the installation parts and accessories to install the air conditioner. Improper installation may result in water leakage, electrical shock and fire, or cause the equipment to fail. The items are not included with the air conditioner must be purchased separately.

Name of Accessories	Q'ty(pc)	Shape	Name of Accessories	Q'ty(pc)	Shape
Manual	2~3		Remote controller	1	
Drain joint (for cooling & heating models)	1		Battery	2	
Seal (for cooling & heating models)	1		Remote controller holder(optional)	1	
Mounting plate	1		Fixing screw for remote controller holder(optional)	2	
Anchor	5~8 (depending on models)		Small Filter (Need to be installed on the back of main air filter by the authorised technician while installing the machine)	1~2 (depending on models)	
Mounting plate fixing screw	5~8 (depending on models)				

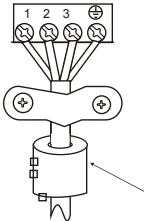
Name	Shape	Cm	Quantity (PC)	
Connecting pipe assembly	Liquid side	Φ 6.35	Parts you must purchase separately. Consult the dealer about the proper pipe size of the unit you purchased.	
		Φ 9.52		
	Gas side	Φ 9.52		
		Φ 12.7		
		Φ 16		
Magnetic ring and belt (if supplied, please refer to the wiring diagram to install it on the connective cable. )	 Pass the belt through the hole of the Magnetic ring to fix it on the cable		Varies by model	

# INSTALLATION SUMMARY

## Indoor Unit

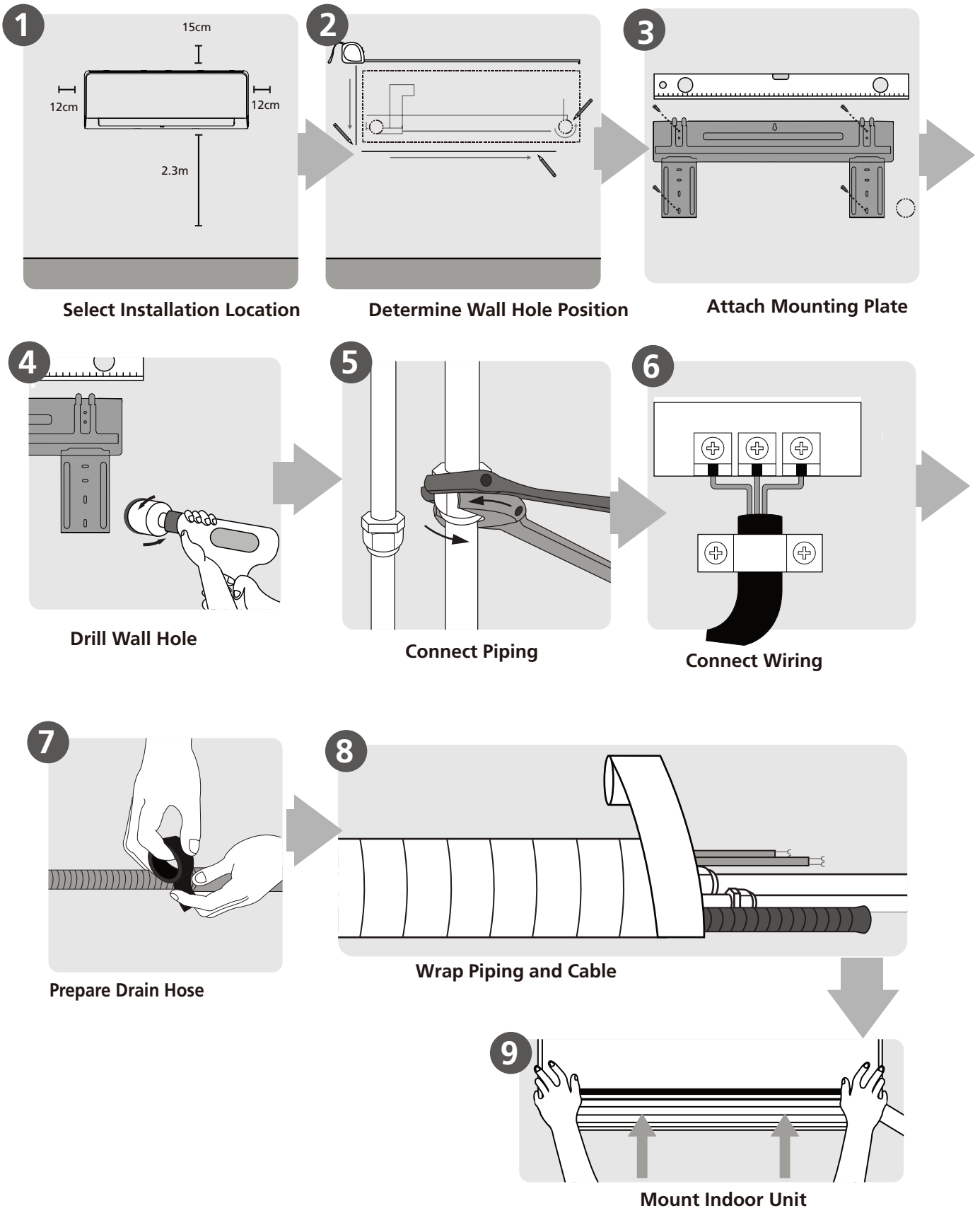

# DESCRIPTION

**NOTE:** The installation must be performed in accordance with the requirements of local and national standards. The installation may be slightly different in different areas.

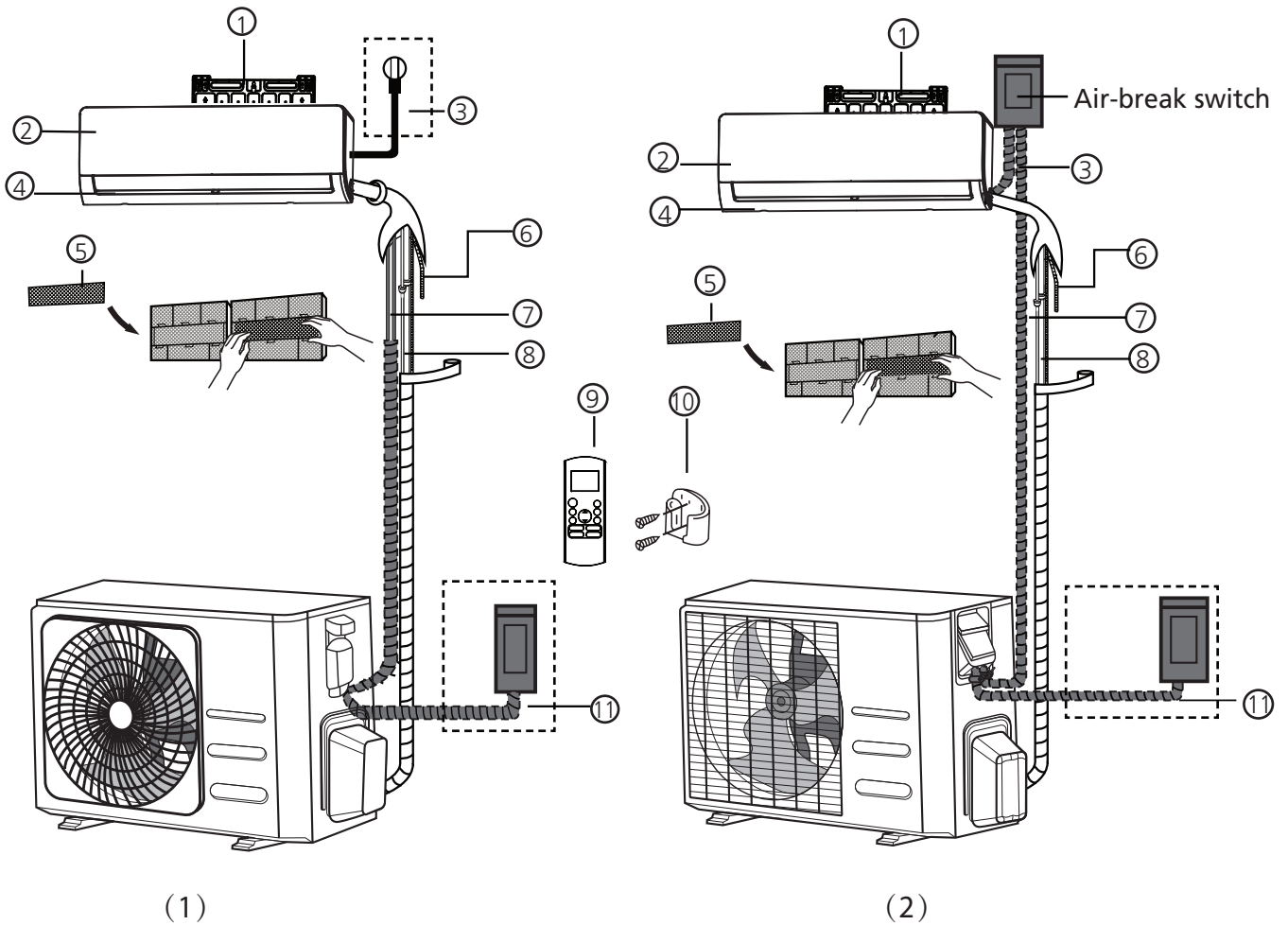

- ① Wall Mounting Plate
- ② Front Panel
- ③ Power Cable (Some Units)
- ④ Louver
- ⑤ Functional Filter (On Back of Main Filter - Some Units)
- ⑥ Drainage Pipe
- ⑦ Signal Cable
- ⑧ Refrigerant Piping
- ⑨ Remote Controller
- ⑩ Remote controller Holder (Some Units)
- ⑪ Outdoor Unit Power Cable (Some Units)

## NOTE ON ILLUSTRATIONS

Illustrations in this manual are for explanatory purposes. The shape of the indoor unit may vary from model to model.

# INDOOR INSTALLATION

## Installation Instructions – Indoor Unit

### PRIOR TO INSTALLATION

Before installing the indoor unit, refer to the label on the product box to make sure that the model number of the indoor unit matches the model number of the outdoor unit.

#### Step 1: Select installation location

Before installing the indoor unit, you must choose an appropriate location. The following are standards that will help you choose an appropriate location for the unit.

#### Proper installation locations meet the following standards:

- ☑ Good air circulation
- ☑ Convenient drainage
- ☑ Noise from the unit will not disturb other people
- ☑ Firm and solid—the location will not vibrate
- ☑ Strong enough to support the weight of the unit
- ☑ A location at least one meter from all other electrical devices (e.g., TV, radio, computer)

#### DO NOT install unit in the following locations:

- ⊘ Near any source of heat, steam, or combustible gas
- ⊘ Near flammable items such as curtains or clothing
- ⊘ Near any obstacle that might block air circulation
- ⊘ Near the doorway
- ⊘ In a location subject to direct sunlight

### NOTE ABOUT WALL HOLE:

If there is no fixed refrigerant piping:

While choosing a location, leave ample room for a wall hole (see Drill wall hole for connective piping step) for the signal cable and refrigerant piping that connect the indoor and outdoor units. The default position for all piping is the right side of the indoor unit (while facing the unit). However, the unit can accommodate piping to both the left and right.

Refer to the following diagram to ensure correct distance from walls and ceiling:

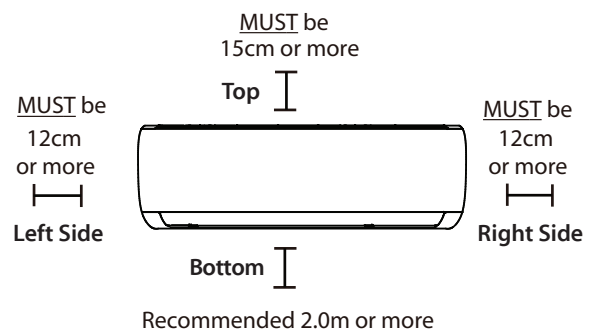

#### Step 2: Attach mounting plate to wall

The mounting plate is the device on which you will mount the indoor unit.

- Remove the screw that attaches the mounting plate to the back of the indoor unit.

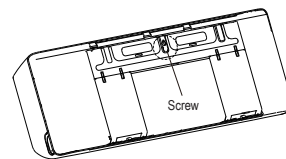

- Secure the mounting plate to the wall with the screws provided. Make sure that mounting plate is flat against the wall.

### NOTE FOR CONCRETE OR BRICK WALLS

If the wall is made of brick, concrete, or similar material, drill 5mm-diameter holes in the wall and insert the sleeve anchors provided. Then secure the mounting plate to the wall by tightening the screws directly into the clip anchors.

**Step 3: Drill wall hole for connective piping**

1. Determine the location of the wall hole based on the position of the mounting plate. Refer to Mounting Plate Dimensions.
2. Using a 65mm or 90mm (depending on models) core drill, drill a hole in the wall.

Make sure that the hole is drilled at a slight downward angle, so that the outdoor end of the hole is lower than the indoor end by about 5mm to 7mm. This will ensure proper water drainage.

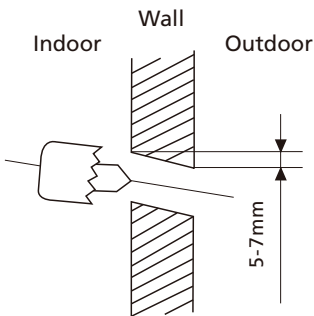

**CAUTION**

When drilling the wall hole, make sure to avoid wires, plumbing, and other sensitive components.

3. Place the protective wall cuff in the hole. This protects the edges of the hole and will help seal it when you finish the installation process.

**MOUNTING PLATE DIMENSIONS**

Different models have different mounting plates. For the different customisation requirements, the shape of the mounting plate may be slightly different. But the installation dimensions are the same for the same size of indoor unit.

Correct orientation of Mounting Plate

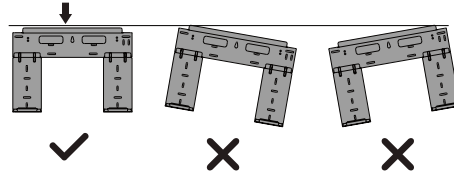

**PIPE HOLE AND WALL CLEARANCE DIMENSIONS**

Use the following diagrams to locate the appropriate service holes for the indoor unit relative to the mounting bracket. Dimensions of the unit edges are supplied to ensure minimum wall clearances can be applied whilst hanging the bracket. See Page 13. The information is also supplied on the packaging.

**HINRP26MB  
HINRP35MB**

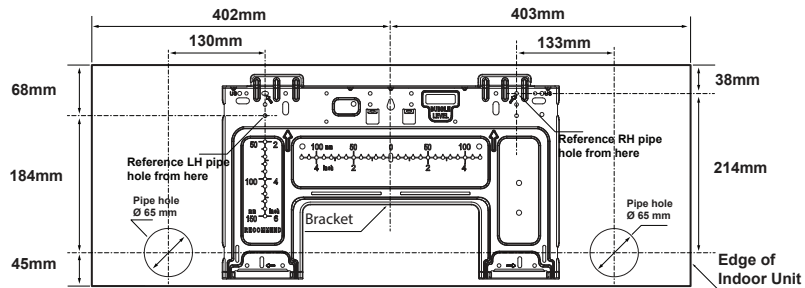

**HINRP50MB  
HINRP60MB**

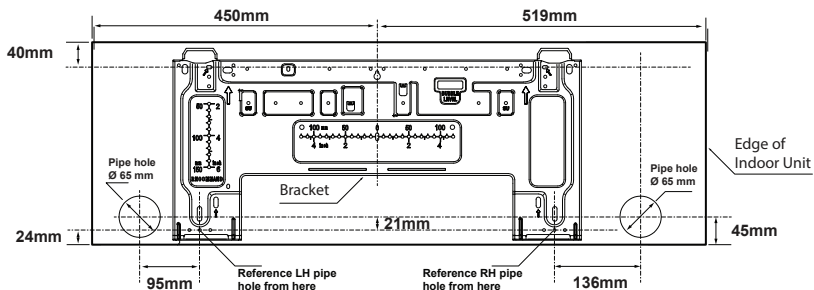

**HINRP70MB  
HINRP80MB**

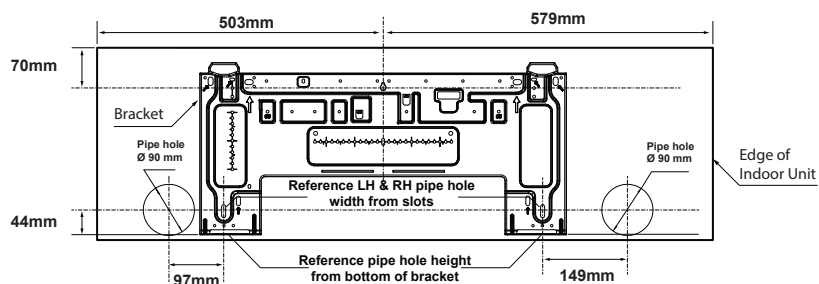

### Step 4: Prepare refrigerant piping

The refrigerant piping is inside an insulating sleeve attached to the back of the unit. You must prepare the piping before passing it through the hole in the wall.

1. Based on the position of the wall hole relative to the mounting plate, choose the side from which the piping will exit the unit.
2. If the wall hole is behind the unit, keep the knock-out panel in place. If the wall hole is to the side of the indoor unit, remove the plastic knock-out panel from that side of the unit. This will create a slot through which your piping can exit the unit. Use needle nose pliers if the plastic panel is too difficult to remove by hand.

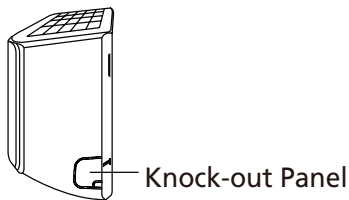

3. If existing connective piping is already embedded in the wall, proceed directly to the **Connect Drain Hose** step. If there is no embedded piping, connect the indoor unit's refrigerant piping to the connective piping that will join the indoor and outdoor units. Refer to the **Refrigerant Piping Connection** section of this manual for detailed instructions.

#### NOTE ON PIPING ANGLE

Refrigerant piping can exit the indoor unit from four different angles: Left-hand side, Right-hand side, Left rear, Right rear.

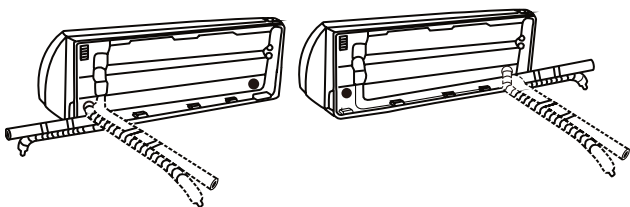

#### CAUTION

Be extremely careful not to dent or damage the piping while bending them away from the unit. Any dents in the piping will affect the unit's performance.

### Step 5: Connect drain hose

By default, the drain hose is attached to the left-hand side of unit (when you're facing the back of the unit). However, it can also be attached to the right-hand side. To ensure proper drainage, attach the drain hose on the same side that your refrigerant piping exits the unit. Attach drain hose extension (purchased separately) to the end of drain hose.

- Wrap the connection point firmly with Teflon tape to ensure a good seal and to prevent leaks
- For the portion of the drain hose that will remain indoors, wrap it with foam pipe insulation to prevent condensation.
- Remove the air filter and pour a small amount of water into the drain pan to make sure that water flows from the unit smoothly.

#### NOTE ON DRAIN HOSE PLACEMENT

Make sure to arrange the drain hose according to the following figures.

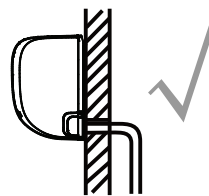

CORRECT

Make sure there are no kinks or dent in drain hose to ensure proper drainage.

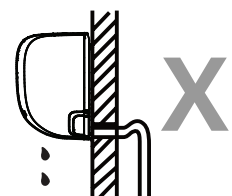

NOT CORRECT

Kinks in the drain hose will create water traps.

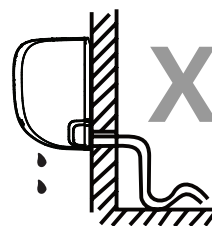

NOT CORRECT

Kinks in the drain hose will create water traps.

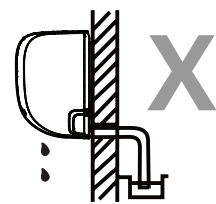

NOT CORRECT

Do not place the end of the drain hose in water or in containers that collect water. This will prevent proper drainage.

#### PLUG THE UNUSED DRAIN HOLE

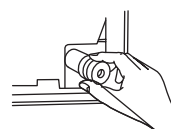

To prevent unwanted leaks you must plug the unused drain hole with the rubber plug provided.

**! BEFORE PERFORMING ANY ELECTRICAL WORK, READ THESE REGULATIONS**

1. All wiring must comply with local and national electrical codes, regulations and must be installed by a licensed electrician.
2. All electrical connections must be made according to the Electrical Connection Diagram located on the panels of the indoor and outdoor units.
3. If there is a serious safety issue with the power supply, stop work immediately. Explain your reasoning to the client, and refuse to install the unit until the safety issue is properly resolved.
4. Supply Voltage should meet data label requirements (220 ~ 240 V). Insufficient power supply can cause malfunction, electrical shock, or fire.
5. If connecting power to fixed wiring, a surge protector and main power switch should be installed.
6. If connecting power to fixed wiring, a switch or circuit breaker that disconnects all poles and has a contact separation of at least 1/8in (3mm) must be incorporated in the fixed wiring. The qualified technician must use an approved circuit breaker or switch.
7. Only connect the unit to an individual branch circuit outlet. Do not connect another appliance to that outlet.
8. Make sure to properly ground the air conditioner.
9. Every wire must be firmly connected. Loose wiring can cause the terminal to overheat, resulting in product malfunction and possible fire.
10. Do not let wires touch or rest against refrigerant tubing, the compressor, or any moving parts within the unit.
11. If the unit has an auxiliary electric heater, it must be installed at least 1 metre away from any combustible materials.
12. To avoid getting an electric shock, never touch the electrical components soon after the power supply has been turned off. After turning off the power, always wait 10 minutes or more before you touch the electrical components.



**WARNING**

**BEFORE PERFORMING ANY ELECTRICAL OR WIRING WORK, TURN OFF THE MAIN POWER TO THE SYSTEM.**

**Step 6: Connect signal and power cables**

The signal cable enables communication between the indoor and outdoor units. You must first choose the right cable size before preparing it for connection.

**Cable Types**

For cable types or equivalent, please refer to AS/NZS 3000 & local rules and regulations.

**Minimum Cross-Sectional Area of Power and Signal Cables (for reference)**

Rated Current of Appliance (A)	Nominal Cross-Sectional Area (mm <sup>2</sup> )
> 3 and ≤ 6	0.75
> 6 and ≤ 10	1
> 10 and ≤ 16	1.5
> 16 and ≤ 25	2.5
> 25 and ≤ 32	4
> 32 and ≤ 40	6

**CHOOSE THE RIGHT CABLE SIZE**

The size of the power supply cable, signal cable, fuse, and switch needed is determined by the maximum current of the unit. The maximum current is indicated on the nameplate located on the side panel of the unit.

**NOTE:** Please choose the right cable size according to local and national rules (Recommended tables are for reference only).



**WARNING**

**ALL WIRING MUST BE PERFORMED STRICTLY IN ACCORDANCE WITH THE WIRING DIAGRAM LOCATED ON THE BACK OF THE INDOOR UNIT'S FRONT PANEL.**

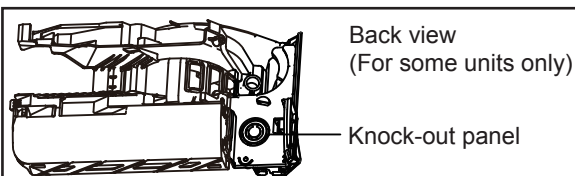
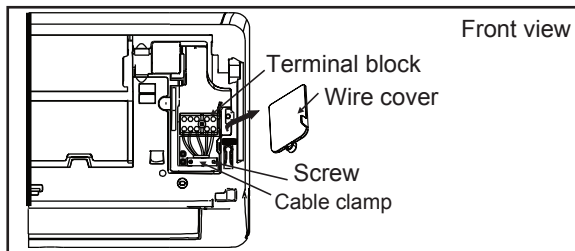

1. Open front panel of the indoor unit.
2. Using a screwdriver, open the wire box cover on the right side of the unit. This will reveal the terminal block.

**NOTE:**

- For the units with conduit tube to connect the cable, remove the big plastic knock-out panel to create a slot through which the conduit tube can be installed.
- For the units with five-core cable, remove the middle small plastic knock-out panel to create a slot through which the cable can exit.
- Use needle nose pliers if the plastic panel is too difficult to remove by hand.

3. Unscrew the cable clamp below the terminal block and place it to the side.
4. Facing the back of the unit, remove the plastic panel on the bottom left-hand side.
5. Feed the signal wire through this slot, from the back of the unit to the front.
6. Facing the front of the unit, connect the wire according to the indoor unit's wiring diagram, connect the u-lug and firmly screw each wire to its corresponding terminal.

**⚠ CAUTION**

**DO NOT MIX UP LIVE AND NULL WIRES**

This is dangerous, and can cause the air conditioning unit to malfunction.

7. After checking to make sure every connection is secure, use the cable clamp to fasten the signal cable to the unit. Screw the cable clamp down tightly.
8. Replace the wire cover on the front of the unit, and the plastic panel on the back.

**⚠ NOTE ABOUT WIRING**

**THE WIRING CONNECTION PROCESS MAY DIFFER SLIGHTLY BETWEEN UNITS AND REGIONS.**

**Step 7: Wrap piping and cables**

Before passing the piping, drain hose, and the signal cable through the wall hole, you must bundle them together to save space, protect them, and insulate them.

1. Bundle the drain hose, refrigerant pipes, and signal cable as shown below:

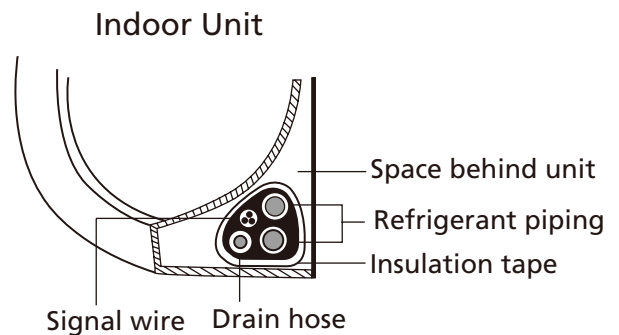
**DRAIN HOSE MUST BE ON BOTTOM**

Make sure that the drain hose is at the bottom of the bundle. Putting the drain hose at the top of the bundle can cause the drain pan to overflow, which can lead to fire or water damage.

**DO NOT INTERTWINE SIGNAL CABLE WITH OTHER WIRES**

While bundling these items together, do not intertwine or cross the signal cable with any other wiring.

2. Using adhesive vinyl tape, attach the drain hose to the underside of the refrigerant pipes.
3. Using insulation tape, wrap the signal wire, refrigerant pipes, and drain hose tightly together. Double-check that all items are bundled.

**DO NOT WRAP ENDS OF PIPING**

When wrapping the bundle, keep the ends of the piping unwrapped. You need to access them to test for leaks at the end of the installation process (refer to **Electrical Checks and Leak Checks** section of this manual).

**Step 8: Mount indoor unit**

**If you installed new connective piping to the outdoor unit, do the following:**

1. If you have already passed the refrigerant piping through the hole in the wall, proceed to Step 4.
2. Otherwise, double-check that the ends of the refrigerant pipes are sealed to prevent dirt or foreign materials from entering the pipes.
3. Slowly pass the wrapped bundle of refrigerant pipes, drain hose, and signal wire through the hole in the wall.
4. Hook the top of the indoor unit on the upper hook of the mounting plate.
5. Check that unit is hooked firmly on mounting by applying slight pressure to the left and right-hand sides of the unit. The unit should not jiggle or shift.
6. Using even pressure, push down on the bottom half of the unit. Keep pushing down until the unit snaps onto the hooks along the bottom of the mounting plate.
7. Again, check that the unit is firmly mounted by applying slight pressure to the left and the right-hand sides of the unit.

**If refrigerant piping is already embedded in the wall, do the following:**

1. Hook the top of the indoor unit on the upper hook of the mounting plate.
2. Use a bracket or wedge to prop up the unit, giving you enough room to connect the refrigerant piping, signal cable, and drain hose.

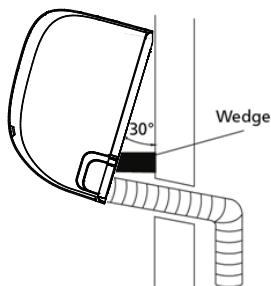

3. Connect drain hose and refrigerant piping (refer to **Refrigerant Piping Connection** section of this manual for instructions).
4. Keep pipe connection point exposed to perform the leak test (refer to **Electrical Checks and Leak Checks** section of this manual).
5. After the leak test, wrap the connection point with insulation tape.
6. Remove the bracket or wedge that is propping up the unit.
7. Using even pressure, push down on the bottom half of the unit. Keep pushing down until the unit snaps onto the hooks along the bottom of the mounting plate.

**UNIT IS ADJUSTABLE**

Keep in mind that the hooks on the mounting plate are smaller than the holes on the back of the unit. If you find that you don't have ample room to connect embedded pipes to the indoor unit, the unit can be adjusted left or right by about 30-50mm, depending on the model.

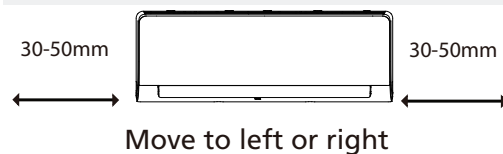

# OUTDOOR INSTALLATION

## Installation Instructions – Outdoor Unit

Install the unit by following your Local Regulations and Municipal Building Codes. They may differ slightly between states.

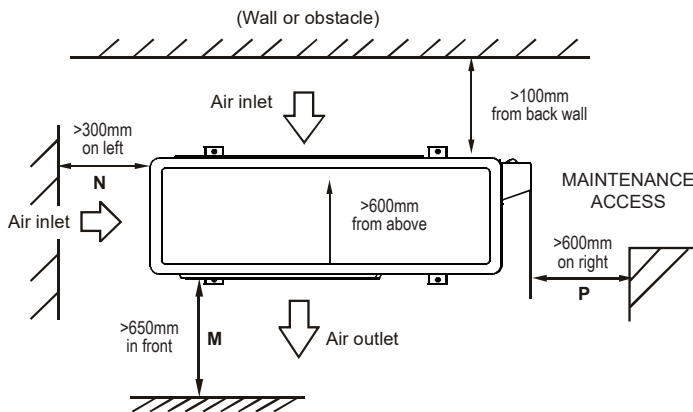

### Step 1: Select installation location

Before installing the outdoor unit, you must choose an appropriate location. The following are standards that will help you choose an appropriate location for the unit.

#### Proper installation locations meet the following standards:

- ☑ Meets all spatial requirements shown in Installation Space Requirements above.
- ☑ Good air circulation and ventilation
- ☑ Firm and solid—the location can support the unit and will not vibrate
- ☑ Noise from the unit will not disturb others
- ☑ Protected from prolonged periods of direct sunlight or rain
- ☑ Where snowfall is anticipated, take appropriate measures to prevent ice buildup and coil damage.

#### DO NOT install unit in the following locations:

- ⊘ Near an obstacle that will block air inlets and outlets
- ⊘ Near a public street, crowded areas, or where noise from the unit will disturb others
- ⊘ Near animals or plants that will be harmed by hot air discharge
- ⊘ Near any source of combustible gas
- ⊘ In a location that is exposed to large amounts of dust
- ⊘ In a location exposed to excessive amounts of salty air

#### SPECIAL CONSIDERATIONS FOR EXTREME WEATHER

##### If the unit is exposed to heavy wind:

Install unit so that air outlet fan is at a 90° angle to the direction of the wind. If needed, build a barrier in front of the unit to protect it from extremely heavy winds. See Figures below.

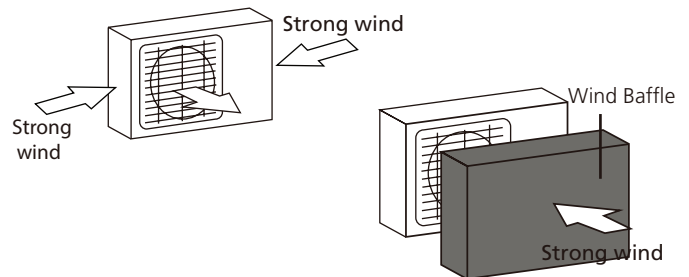

##### If the unit is frequently exposed to heavy rain or snow:

Build a shelter above the unit to protect it from the rain or snow. Be careful not to obstruct air flow around the unit.

##### If the unit is frequently exposed to salty air (seaside):

Use outdoor unit that is specially designed to resist corrosion.

**Step 2: Install drain joint(Heat pump unit only)**

Before bolting the outdoor unit in place, you must install the drain joint at the bottom of the unit. Note that there are two different types of drain joints depending on the type of outdoor unit.

**If the drain joint comes with a rubber seal** (see Fig. A), do the following:

1. Fit the rubber seal on the end of the drain joint that will connect to the outdoor unit.
2. Insert the drain joint into the hole in the base pan of the unit.
3. Rotate the drain joint 90° until it clicks in place facing the front of the unit.
4. Connect a drain hose extension (not included) to the drain joint to redirect water from the unit during heating mode.

**If the drain joint doesn't come with a rubber seal** (see Fig. B), do the following:

1. Insert the drain joint into the hole in the base pan of the unit. The drain joint will click in place.
2. Connect a drain hose extension (not included) to the drain joint to redirect water from the unit during heating mode.

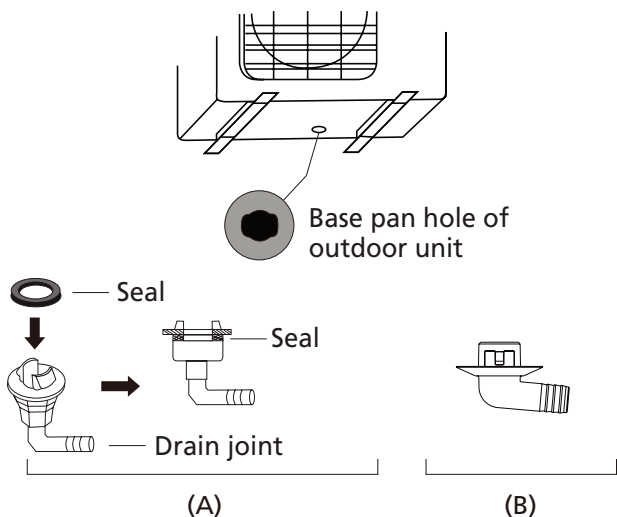

**Step 3: Anchor outdoor unit**

The outdoor unit can be anchored to the ground or to a wall-mounted bracket with bolt (M10). Prepare the installation base of the unit according to the dimensions below.

**UNIT MOUNTING DIMENSIONS**

The following is a list of different outdoor unit sizes and the distance between their mounting feet. Prepare the installation base of the unit according to the dimensions below.

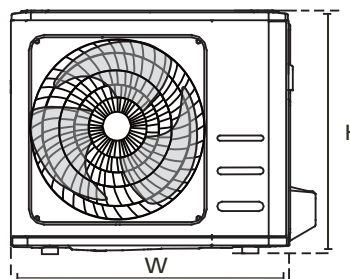
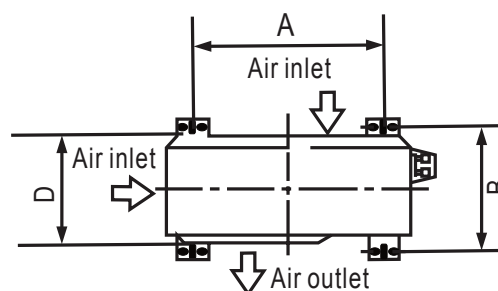

**! IN COLD CLIMATES**

In cold climates, make sure that the drain hose is as vertical as possible to ensure swift water drainage. If water drains too slowly, it can freeze in the hose and flood the unit.

Outdoor Unit Dimensions (mm) W x H x D	Mounting Hole Pitch Dimensions	
	Pitch A (mm)	Pitch B (mm)
805 x 554 x 330	511	317
890 x 673 x 342	663	354

To install the unit on the ground or on a concrete mounting platform, do the following:

1. Mark the positions for four expansion bolts based on dimensions chart on Page 21.
2. Pre-drill holes for expansion bolts.
3. Place a nut on the end of each expansion bolt.
4. Hammer expansion bolts into the pre-drilled holes.
5. Remove the nuts from expansion bolts, and place outdoor unit on bolts.
6. Put washer on each expansion bolt, then replace the nuts.
7. Using a wrench, tighten each nut until snug.

 **WARNING**

**WHEN DRILLING INTO CONCRETE, EYE PROTECTION IS RECOMMENDED AT ALL TIMES.**

To install the unit on a wall-mounted bracket, do the following:

 **CAUTION**

Make sure that the wall is made of solid brick, concrete, or of similarly strong material. **The wall must be able to support at least four times the weight of the unit.**

1. Mark the position of bracket holes based on dimensions chart.
2. Pre-drill the holes for the expansion bolts.
3. Place a washer and nut on the end of each expansion bolt.
4. Thread expansion bolts through holes in mounting brackets, put mounting brackets in position, and hammer expansion bolts into the wall.
5. Check that the mounting brackets are level.
6. Carefully lift unit and place its mounting feet on brackets.
7. Bolt the unit firmly to the brackets.
8. If allowed, install the unit with rubber gaskets to reduce vibrations and noise.

**Step 4: Connect signal and power cables**

The outside unit's terminal block is protected by an electrical wiring cover on the side of the unit. A comprehensive wiring diagram is printed on the inside of the wiring cover.

**⚠ WARNING**

**BEFORE PERFORMING ANY ELECTRICAL OR WIRING WORK, TURN OFF THE MAIN POWER TO THE SYSTEM.**

1. Prepare the cable for connection:

**USE THE RIGHT CABLE**

Please choose the right cable refer to "Cable types" on page 16.

**CHOOSE THE RIGHT CABLE SIZE**

The size of the power supply cable, signal cable, fuse, and switch needed is determined by the maximum current of the unit. The maximum current is indicated on the nameplate located on the side panel of the unit.

NOTE: Choose the appropriate cable size according the Minimum Circuit Current Carrying Capacity indicated on the nameplate of the unit.

- a. Using wire strippers, strip the rubber jacket from both ends of cable to reveal about 40mm of the wires inside.
- b. Strip the insulation from the ends of the wires.
- c. Using a wire crimper, crimp u-lugs on the ends of the wires.

**PAY ATTENTION TO LIVE WIRE**

While crimping wires, make sure you clearly distinguish the Live ("L") Wire from other wires.

**⚠ WARNING**

**ALL WIRING WORK MUST BE PERFORMED STRICTLY IN ACCORDANCE WITH THE WIRING DIAGRAM LOCATED INSIDE OF WIRE COVER OF THE OUTDOOR UNIT .**

2. Unscrew the electrical wiring cover and remove it.
3. Unscrew the cable clamp below the terminal block and place it to the side.
4. Connect the wire according to the wiring diagram, and firmly screw the u-lug of each wire to its corresponding terminal.
5. After checking to make sure every connection is secure, loop the wires around to prevent rain water from flowing into the terminal.
6. Using the cable clamp, fasten the cable to the unit. Screw the cable clamp down tightly.

7. Insulate unused wires with PVC electrical tape. Arrange them so that they do not touch any electrical or metal parts.
8. Replace the wire cover on the side of the unit, and screw it in place.

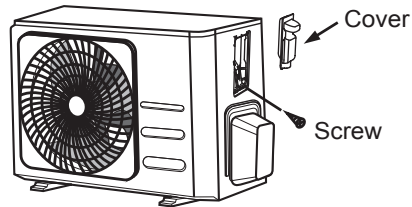

**NOTE:** If the cable clamp looks like the following, please select the appropriate through-hole according to the diameter of the wire.

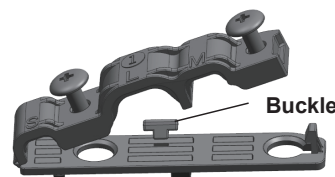

Three size hole: Small, Large, Medium

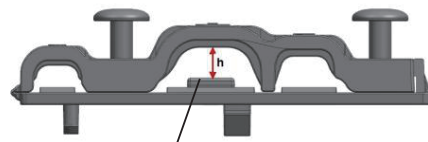

When the cable is not fasten enough, use the buckle to prop it up, so it can be clamped tightly.

**Wiring of Terminal Block**

1. Remove the wire cover from the unit by loosening the 3 screws.
2. Dismount caps on the conduit panel.
3. Temporarily mount the conduit tubes(not included) on the conduit panel.
4. Properly connect both the power supply and low voltage lines to the corresponding terminals on the terminal block.
5. Ground the unit in accordance with local codes.
6. Be sure to size each wire allowing several inches longer than the required length for wiring.
7. Use lock nuts to secure the conduit tubes.

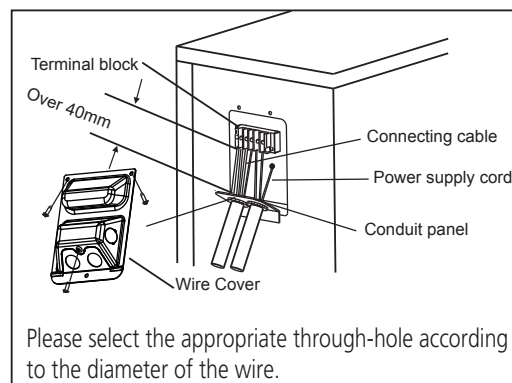

# REFRIGERANT PIPING CONNECTION

When connecting refrigerant piping, **do not** let substances or gases other than the specified refrigerant enter the unit. The presence of other gases or substances will lower the unit's capacity, and can cause abnormally high pressure in the refrigeration cycle. This can cause explosion and injury.

## Note on Pipe Length

The length of refrigerant piping will affect the performance and energy efficiency of the unit. Nominal efficiency is tested on units with a pipe length of 5 metres.

A minimum pipe run of 3 metres is required to minimise vibration & excessive noise.

Refer to the table below for specifications on the maximum length and drop height of piping.

Maximum Length and Drop Height of Refrigerant Piping per Unit Model

Model	Capacity (kW)	Length (m)	Mx Drop Height (m)
R32 Inverter Split Air Conditioner	<4.4	25	10
	≥4.4 and <7	30	20
	≥7 and <10.5	50	25

## Connection Instructions - Refrigerant Piping

### Step 1: Cut pipes

When preparing refrigerant pipes, take extra care to cut and flare them properly. This will ensure efficient operation and minimise the need for future maintenance.

1. Measure the distance between the indoor and outdoor units.
2. Using a pipe cutter, cut the pipe a little longer than the measured distance.
3. Make sure that the pipe is cut at a perfect 90° angle.

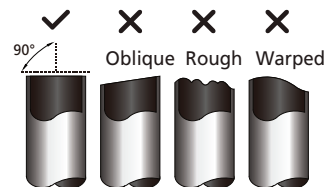

### **DO NOT DEFORM PIPE WHILE CUTTING**

Take care not to damage, dent, or deform the pipe while cutting. This may adversely affect the heating efficiency of the unit.

**Step 2: Remove burrs**

Burrs can affect the air-tight seal of refrigerant piping connection. They must be completely removed.

1. Hold the pipe at a downward angle to prevent burrs from falling into the pipe.
2. Using a reamer or deburring tool, remove all burrs from the cut section of the pipe.

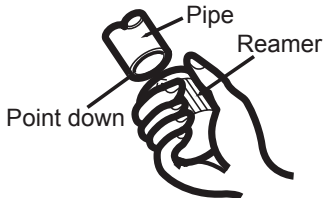

**Step 3: Flare pipe ends**

Proper flaring is essential to achieve an airtight seal.

1. After removing burrs from cut pipe, seal the ends with PVC tape to prevent foreign materials from entering the pipe.
2. Sheath the pipe with insulating material.
3. Place flare nuts on both ends of pipe. Make sure they are facing in the right direction, because you can't put them on or change their direction after flaring.

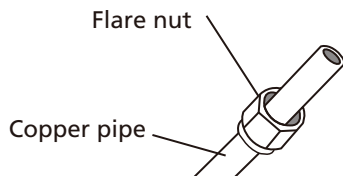

4. Remove PVC tape from ends of pipe when ready to perform flaring work.
5. Clamp flare form on the end of the pipe. The end of the pipe must extend beyond the edge of the flare form in accordance with the dimensions shown in the table below.

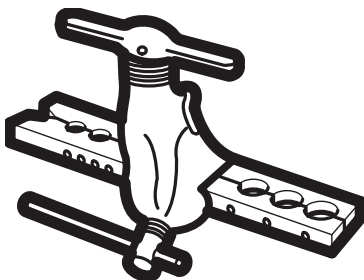

**PIPING EXTENSION BEYOND FLARE FORM**

Outer Diameter of Pipe (mm)	A (mm)	
	Min.	Max .
Ø 6.35	0.7	1.3
Ø 9.52	1.0	1.6
Ø12.7	1.0	1.8
Ø 16	2.0	2.2
Ø 19	2.0	2.4

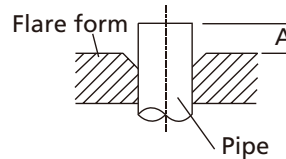

6. Place flaring tool onto the form.
7. Turn the handle of the flaring tool clockwise until the pipe is fully flared.
8. Remove the flaring tool and flare form, then inspect the end of the pipe for cracks and even flaring.

**Step 4: Connect pipes**

When connecting refrigerant pipes, be careful not to use excessive torque or to deform the piping in any way. You should first connect the low-pressure pipe, then the high-pressure pipe.

**MINIMUM BEND RADIUS**

When bending connective refrigerant piping, the minimum bending radius is 10cm.

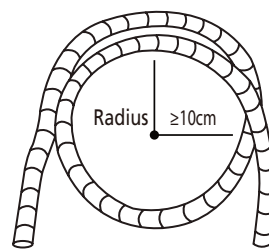

**Instructions for Connecting Piping to Indoor Unit**

1. Align the center of the two pipes that you will connect.

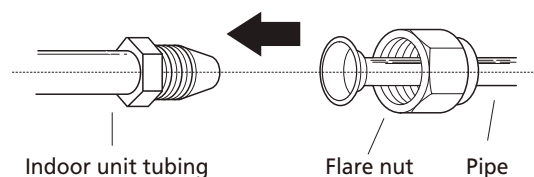



2. Tighten the flare nut as tightly as possible by hand.
3. Using a spanner, grip the nut on the unit tubing.
4. While firmly gripping the nut on the unit tubing, use a torque wrench to tighten the flare nut according to the torque values in the **Torque Requirements** table below. Loosen the flaring nut slightly, then tighten again.

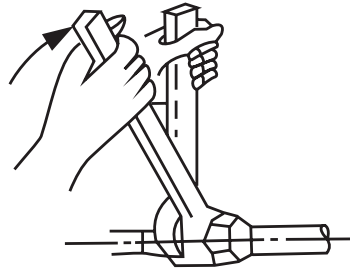

**TORQUE REQUIREMENTS**

Outer Diameter of Pipe (mm)	Tightening Torque (N•m)	Flare dimension(B) (mm)	Flare shape
Ø 6.35	18~20	8.4~8.7	
Ø 9.52	32~39	13.2~13.5	
Ø 12.7	49~59	16.2~16.5	
Ø 16	57~71	19.2~19.7	
Ø 19	67~101	23.2~23.7	

**⊘ DO NOT USE EXCESSIVE TORQUE**

Excessive force can break the nut or damage the refrigerant piping. You must not exceed torque requirements shown in the table above.

**Instructions for Connecting Pipe to Outdoor Unit**

1. Unscrew the cover from the packed valve on the side of the outdoor unit.
2. Remove protective caps from ends of valves.
3. Align flared pipe end with each valve, and tighten the flare nut as tightly as possible by hand.
4. Using a spanner, grip the body of the valve. Do not grip the nut that seals the service valve.
5. While firmly gripping the body of the valve, use a torque wrench to tighten the flare nut according to the correct torque values.
6. Loosen the flaring nut slightly, then tighten again.
7. Repeat Steps 3 to 6 for the remaining pipe.

**! USE SPANNER TO GRIP MAIN BODY OF VALVE**

Torque from tightening the flare nut can snap off other parts of valve.

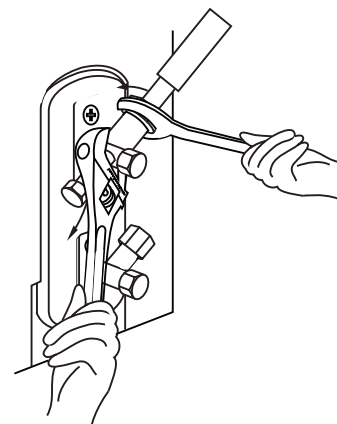
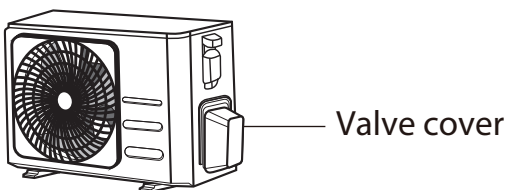

5. While firmly gripping the body of the valve, use a torque wrench to tighten the flare nut according to the correct torque values.

# AIR EVACUATION

## Preparations and Precautions

Air and foreign matter in the refrigerant circuit can cause abnormal rises in pressure, which can damage the air conditioner, reduce its efficiency, and cause injury. Use a vacuum pump and manifold gauge to evacuate the refrigerant circuit, removing any non-condensable gas and moisture from the system.

Evacuation should be performed upon initial installation and when unit is relocated.

### BEFORE PERFORMING EVACUATION

- ☑ Check to make sure the connective pipes between the indoor and outdoor units are connected properly.
- ☑ Check to make sure all wiring is connected properly.

### Evacuation Instructions

1. Connect the charge hose of the manifold gauge to service port on the outdoor unit's low pressure valve.
2. Connect another charge hose from the manifold gauge to the vacuum pump.
3. Open the Low Pressure side of the manifold gauge. Keep the High Pressure side closed.
4. Turn on the vacuum pump to evacuate the system.
5. Run the vacuum for at least 15 minutes, or until the Compound Meter reads  $-76\text{cmHg}$  ( $-10^5\text{Pa}$ ).

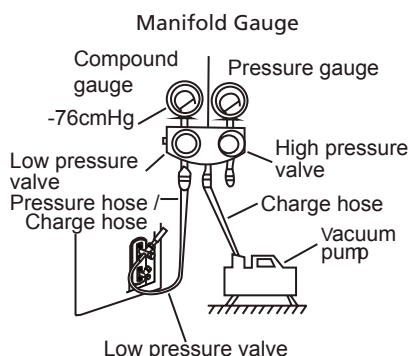

6. Close the Low Pressure side of the manifold gauge, and turn off the vacuum pump.
7. Wait for 5 minutes, then check that there has been no change in system pressure.

8. If there is a change in system pressure, refer to Gas Leak Check section for information on how to check for leaks. If there is no change in system pressure, unscrew the cap from the packed valve (high pressure valve).
9. Insert hexagonal wrench into the packed valve (high pressure valve) and open the valve by turning the wrench in a  $1/4$  counterclockwise turn. Listen for gas to exit the system, then close the valve after 5 seconds.
10. Watch the Pressure Gauge for one minute to make sure that there is no change in pressure. The Pressure Gauge should read slightly higher than atmospheric pressure.
11. Remove the charge hose from the service port.

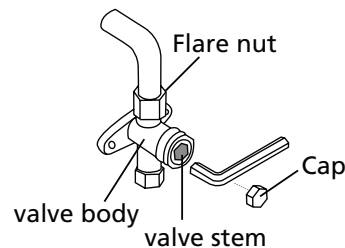

12. Using hexagonal wrench, fully open both the high pressure and low pressure valves.
13. Tighten valve caps on all three valves (service port, high pressure, low pressure) by hand. You may tighten it further using a torque wrench if needed.

### ! OPEN VALVE STEMS GENTLY

When opening valve stems, turn the hexagonal wrench until it hits against the stopper. Do not try to force the valve to open further.

## Note on Adding Refrigerant

Some systems require additional charging depending on pipe lengths. The standard pipe length varies according to local regulations.

In other areas, the standard pipe length is 5m. The refrigerant should be charged from the service port on the outdoor unit's low pressure valve. The additional refrigerant to be charged can be calculated using the following formula:

### ADDITIONAL REFRIGERANT PER PIPE LENGTH

Connective Pipe Length (m)	Air Purging Method	Additional Refrigerant	
≤ Standard pipe length	Vacuum Pump	N/A	
> Standard pipe length	Vacuum Pump	Liquid Side: Ø 6.35 R32: (Pipe length – standard length) x 12g/m	Liquid Side: Ø 9.52 R32: (Pipe length – standard length) x 24g/m

# ELECTRICAL AND GAS LEAK CHECKS

## Before Test Run

Only perform test run after you have completed the following steps:

- **Electrical Safety Checks** – Confirm that the unit's electrical system is safe and operating properly
- **Gas Leak Checks** – Check all flare nut connections and confirm that the system is not leaking
- Confirm that gas and liquid (high and low pressure) valves are fully open

## Electrical Safety Checks

After installation, confirm that all electrical wiring is installed in accordance with local and national regulations, and according to the Installation Manual.

### BEFORE TEST RUN

Check Grounding Work

Measure grounding resistance by visual detection and with grounding resistance tester. Grounding resistance must be less than 0.1  $\Omega$ .

### DURING TEST RUN

Check for Electrical Leakage

During the Test Run, use an electroprobe and multimeter to perform a comprehensive electrical leakage test.

If electrical leakage is detected, turn off the unit immediately and call a licensed electrician to find and resolve the cause of the leakage.



## WARNING – RISK OF ELECTRIC SHOCK

**ALL WIRING MUST COMPLY WITH LOCAL AND NATIONAL ELECTRICAL CODES, AND MUST BE INSTALLED BY A LICENSED ELECTRICIAN.**

## Gas Leak Checks

There are two different methods to check for gas leaks.

### Soap and Water Method

Using a soft brush, apply soapy water or liquid detergent to all pipe connection points on the indoor unit and outdoor unit. The presence of bubbles indicates a leak.

### Leak Detector Method

If using leak detector, refer to the device's operation manual for proper usage instructions.

### AFTER PERFORMING GAS LEAK CHECKS

After confirming that all pipe connection points DO NOT leak, replace the valve cover on the outside unit.

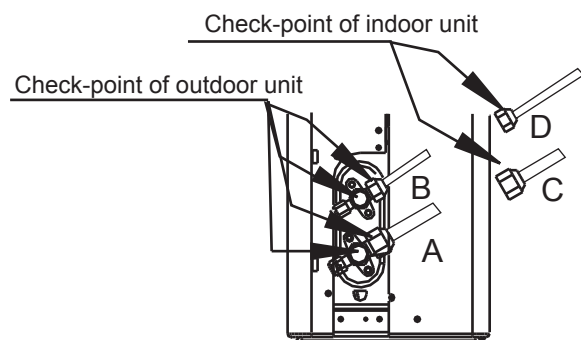

- A: Low pressure stop valve
- B: High pressure stop valve
- C & D: Indoor unit flare nuts

## Test Run Checks

Perform the **Test Run** for at least 30 minutes.

1. Connect power to the unit.
2. Press the **ON/OFF** button on the remote controller to turn it on.
3. Press the **MODE** button to scroll through the following functions, one at a time:
  - COOL – Select lowest possible temperature
  - HEAT – Select highest possible temperature
4. Let each function run for 5 minutes, and perform the following checks:

List of Checks to Perform	PASS/FAIL	
No electrical leakage		
Unit is properly grounded		
All electrical terminals properly covered		
Indoor and outdoor units are solidly installed		
All pipe connection points do not leak	Outdoor (2):	Indoor (2):
Water drains properly from drain hose		
All piping is properly insulated		
Unit performs COOL function properly		
Unit performs HEAT function properly		
Indoor unit louvers rotate properly		
Indoor unit responds to remote controller		

During operation, the pressure of the refrigerant circuit will increase. This may reveal leaks that were not present during the initial leak check. Take time during the Test Run to double-check that all refrigerant pipe connection points do not have leaks. Refer to **Gas Leak Check** section for instructions.

5. After the Test Run is successfully completed, and you confirm that all checks points in List of Checks to Perform have PASSED, do the following:
  - a. Using remote control, return unit to normal operating temperature.
  - b. Using insulation tape, wrap the indoor refrigerant pipe connections that was left uncovered during the indoor unit installation process.

### IF AMBIENT TEMPERATURE IS BELOW 17°C

**DO NOT** use the remote controller to turn on the COOL function when the ambient temperature is below 17°C. In this instance, use the **MANUAL CONTROL** button to test the COOL function.

1. Lift the front panel of the indoor unit, and raise it until it clicks in place.
2. The **MANUAL CONTROL** button is located on the right-hand side of the unit. Press it 2 times to select the COOL function.
3. Perform Test Run as normal.

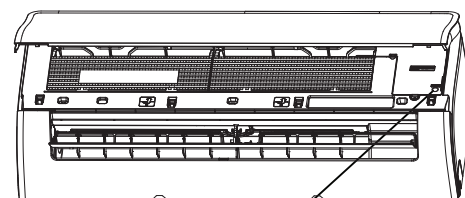

Manual control button

# CHECKLIST

## FINAL CHECKLIST



The checklist is **ONLY** to be completed by an **Authorised Person**.

Check Item	✓	What can happen if not checked
Is the indoor unit installed securely?	<input type="checkbox"/>	Falling, vibration, noise
Has an inspection been made to check for gas leakage?	<input type="checkbox"/>	No cooling or heating
Has all thermal insulation been completed (vapour pipes, liquid pipes, indoor portions of the drain hose extension)?	<input type="checkbox"/>	Condensation
Is the drainage secure?	<input type="checkbox"/>	Water leakage
Are the electric wires installed correctly?	<input type="checkbox"/>	No cooling or heating, may cause electrical shock or electrical fire.
Is the wiring in accordance within the specifications?	<input type="checkbox"/>	Operation failure, electrical fire
Are all inlets / outlets of the indoor and outdoor units free of any obstructions?	<input type="checkbox"/>	No cooling or heating
Are the stop valves open?	<input type="checkbox"/>	No cooling or heating
Are the pipes designed for use with R32?	<input type="checkbox"/>	Pipe or pipe connection leakage
Has a leak test been carried out for the pipe connections?	<input type="checkbox"/>	Pipe connection leakage
Has air purging been carried out?	<input type="checkbox"/>	No cooling or heating
Has the appliance been tested for correct operation?	<input type="checkbox"/>	No cooling or heating
Is the end user fully aware of the operating procedure?	<input type="checkbox"/>	Incorrect operation

**If you have answered no to any of the above, you must check and correct before appliance hand-over to customer.**

# SPECIFICATIONS

RINNAI - PB Series Hi-Wall Split System		HSNRP26B	HSNRP35B	
Nominal Capacity	kW	2.65	3.55	
Power Supply to Outdoor Unit	V - Ph - Hz	220~240 - 1 - 50		
Recommended Circuit Breaker	A	16	16	
Connectivity	-	Wi-Fi Enabled		
Demand Response Enabling Device	-	DRED Enabled		
Cooling	Rated Capacity	kW	2.65	3.5
	Capacity Range		1.00-3.50	1.50-4.90
	Rated Power Input	W	530	790
	Rated Current (Range)	A	2.5	3.8
	AEER	W/W	4.98	4.42
	TCSPF (Hot & Humid / Mixed / Cold)		8.02 / 7.497 / 7.887	7.00 / 6.76 / 7.07
	Star Rating (Hot & Humid / Mixed / Cold)	-	6.5 / 5.5 / 6.0 STAR	5.0 / 5.0 / 5.5 STAR
Heating	Rated Capacity	kW	2.7	3.8
	Capacity Range		1.40-4.00	1.80-5.10
	Rated Power Input	W	510	830
	Rated Current (Range)	A	2.5	5
	ACOP	W/W	5.273	4.564
	HSPF (Hot & Humid / Mixed / Cold)		5.79 / 5.35 / 4.96	6.23 / 5.22 / 4.50
	Star Rating (Hot & Humid / Mixed / Cold)	-	4.0 / 3.5 / 3.0 STAR	4.5 / 3.5 / 3 STAR
Maximum Input Power (Cooling / Heating)	W	2300	2300	
Maximum Input Current (Cooling / Heating)	A	10.5	10.5	
Suitable Area Coverage (up to 2.6m insulated ceiling)	m <sup>2</sup>	11-17	16-23	
Indoor Unit Model No.		HINRP26MB	HINRP35MB	
Air Flow (Turbo / Hi / Med / Lo / Min)	L/s	175 / 139 / 100 / 83 / 56	183 / 147 / 106 / 86 / 58	
Moisture Removal	L/h	1.00	1.20	
Air Flow (Turbo / Hi / Med / Lo / Min)	m <sup>3</sup> /h	630 / 500 / 360 / 300 / 200	660 / 530 / 380 / 310 / 210	
Sound Pressure Level @ 1m (Turbo / Hi / Med / Lo / Min)	dB(A)	46.4 / 39 / 32.5 / 30 / 24.5	46.7 / 39 / 32.5 / 30 / 24.5	
Air Swing Louvres Type	-	4-way swing		
Dimensions	Dimension (W x H x D)	mm	802 x 295 x 200	802 x 295 x 200
	Packing (W x H x D)		875 x 375 x 288	875 x 375 x 288
	Net / Gross Weight	kg	8.5 / 11.5	8.5 / 11.5
Operating Range	Cooling	°C	16 ~ 32	16 ~ 32
	Heating		0 ~ 30	0 ~ 30
Outdoor Unit Model No.		HONRP26B	HONRP35B	
Sound Power Level	dB(A)	57.8	58.5	
Sound Pressure Level @ 1m		55.5	55.5	
Dimensions	Dimension (W x H x D)	mm	805 x 554 x 330	805 x 554 x 330
	Packing (W x H x D)		915 x 615 x 370	915 x 615 x 370
	Net / Gross Weight	kg	32.2 / 35.1	32.2 / 35.1
Refrigerant	Charged Volume	kg	0.9	0.9
	Pipe Size: Liquid / Gas	mm	6.35mm / 9.52mm	6.35mm / 9.52mm
	Maximum Pipe Length	m	25	25
	Chargeless Length		10	10
	Extra Charge for Lengths >10m	g/m	12	12
	Maximum Vertical Separation	m	10	10
Ambient Temperature Limits	Cooling	°C	0 ~ 52	0 ~ 52
	Heating		-15~24	-15~24

Capacities tested in accordance with AS/NZS 3823.2, with 5m interconnecting pipe length. With our policy of continuous improvement, we reserve the right to change, or discontinue at any time, specifications or designs without notice.

## SPECIFICATIONS

RINNAI - PB Series Hi-Wall Split System		HSNRP50B	HSNRP60B	
Nominal Capacity	kW	5	6	
Power Supply to Outdoor Unit	V - Ph - Hz			
Recommended Circuit Breaker	A	20	20	
Connectivity	-	Wi-Fi Enabled		
Demand Response Enabling Device	-	DRED Enabled		
Cooling	Rated Capacity	kW	5.0	6.0
	Capacity Range		2.10-7.20	2.10-7.20
	Rated Power Input	W	1280	1750
	Rated Current (Range)	A	5.8	8.0
	AEER	W/W	3.90	3.42
	TCSPF (Hot & Humid / Mixed / Cold)		6.19 / 5.83 / 6.17	5.86 / 5.61 / 5.99
	Star Rating (Hot & Humid / Mixed / Cold)	-	4.5 / 4.0 / 4.5 STAR	4.0 / 4.0 / 4.0 STAR
Heating	Rated Capacity	kW	5.4	6.5
	Capacity Range		2.50-7.80	2.50-7.80
	Rated Power Input	W	1340	1686
	Rated Current (Range)	A	6	8.2
	ACOP	W/W	4.019	3.847
	HSPF (Hot & Humid / Mixed / Cold)		4.89 / 4.31 / 3.71	5.31 / 4.29 / 3.52
	Star Rating (Hot & Humid / Mixed / Cold)	-	3.0 / 2.5 / 2.0 STAR	3.5 / 2.5 / 1.5 STAR
Maximum Input Power (Cooling / Heating)	W	3600	3600	
Maximum Input Current (Cooling / Heating)	A	15.5	15.5	
Suitable Area Coverage (up to 2.6m insulated ceiling)	m <sup>2</sup>	23-33	27-40	
Indoor Unit Model No.		HINRP50MB	HINRP60MB	
Air Flow (Turbo / Hi / Med / Lo / Min)	L/s	264 / 222 / 167 / 139 / 89	264 / 222 / 167 / 139 / 89	
Moisture Removal	L/h	1.80	2.10	
Air Flow (Turbo / Hi / Med / Lo / Min)	m <sup>3</sup> /h	950 / 800 / 600 / 500 / 322	950 / 800 / 600 / 500 / 322	
Sound Pressure Level @ 1m (Turbo / Hi / Med / Lo / Min)	dB(A)	47.1 / 44.5 / 38 / 34.5 / 28	47.1 / 44.5 / 38 / 34.5 / 28	
Air Swing Louvres Type	-	4-way swing		
Dimensions	Dimension (W x H x D)	mm	971 x 321 x 228	971 x 321 x 228
	Packing (W x H x D)		1045 x 405 x 308	1045 x 405 x 308
	Net / Gross Weight	kg	11.1 / 15.2	11.1 / 15.2
Operating Range	Cooling	°C	16 ~ 32	16 ~ 32
	Heating		0 ~ 30	0 ~ 30
Outdoor Unit Model No.		HONRP50B	HONRP60B	
Sound Power Level	dB(A)	65.2	65.2	
Sound Pressure Level @ 1m		59.5	59.5	
Dimensions	Dimension (W x H x D)	mm	890 x 673 x 342	890 x 673 x 342
	Packing (W x H x D)		995 x 740 x 398	995 x 740 x 398
	Net / Gross Weight	kg	38.3 / 41.6	38.3 / 41.6
Refrigerant	Charged Volume	kg	1.26	1.26
	Pipe Size: Liquid / Gas	mm	6.35mm / 12.7mm	6.35mm / 12.7mm
	Maximum Pipe Length	m	30	30
	Chargeless Length		10	10
	Extra Charge for Lengths >10m	g/m	12	12
	Maximum Vertical Separation	m	20	20
Ambient Temperature Limits	Cooling	°C	0 ~ 50	0 ~ 50
	Heating		-15 ~ 24	-15 ~ 24

Capacities tested in accordance with AS/NZS 3823.2, with 5m interconnecting pipe length. With our policy of continuous improvement, we reserve the right to change, or discontinue at any time, specifications or designs without notice.



<b>RINNAI - PB Series Hi-Wall Split System</b>			<b>HSNRP70B</b>	<b>HSNRP80B</b>
Nominal Capacity	kW		7	8
Power Supply to Outdoor Unit	V - Ph - Hz			
Recommended Circuit Breaker	A		25	25
Connectivity	-		Wi-Fi Enabled	
Demand Response Enabling Device	-		DRED Enabled	
Cooling	Rated Capacity	kW	7.15	7.8
	Capacity Range		3.20-8.0	3.20-8.0
	Rated Power Input	W	1920	2200
	Rated Current (Range)	A	10.5	10.5
	AEER	W/W	3.53	3.39
	TCSPF (Hot & Humid / Mixed / Cold)		5.36 / 5.14 / 5.37	5.38 / 5.21 / 5.48
	Star Rating (Hot & Humid / Mixed / Cold)	-	3.5 / 3.5 / 3.5	3.5 / 3.5 / 3.5
Heating	Rated Capacity	kW	7.8	8.3
	Capacity Range		2.20-8.8	2.20-8.8
	Rated Power Input	W	1990	2280
	Rated Current (Range)	A	10.8	10.8
	ACOP	W/W	3.734	3.611
	HSPF (Hot & Humid / Mixed / Cold)		4.97 / 4.32 / 3.82	4.96 / 4.20 / 3.66
	Star Rating (Hot & Humid / Mixed / Cold)	-	3.0 / 2.5 / 2.0	3.0 / 2.5 / 2.0
Maximum Input Power (Cooling / Heating)	W	4050	4050	
Maximum Input Current (Cooling / Heating)	A	17.5	17.5	
Suitable Area Coverage (up to 2.6m insulated ceiling)	m <sup>2</sup>	32-47	32-47	
<b>Indoor Unit Model No.</b>			<b>HINRP70MB</b>	<b>HINRP80B</b>
Air Flow (Turbo / Hi / Med / Lo / Min)	L/s		382 / 303 / 250 / 229 / 147	382 / 303 / 250 / 229 / 147
Moisture Removal	L/h		2.40	3.00
Air Flow (Turbo / Hi / Med / Lo / Min)	m <sup>3</sup> /h		1375 / 1090 / 900 / 825 / 530	1375 / 1090 / 900 / 825 / 530
Sound Pressure Level @ 1m (Turbo / Hi / Med / Lo / Min)	dB(A)		57.645 / 45 / 39 / 33.5 / 29.5	57.645 / 45 / 39 / 33.5 / 29.5
Air Swing Louvres Type	-		4-way swing	
Dimensions	Dimension (W x H x D)	mm	1082 x 337 x 234	1082 x 337 x 234
	Packing (W x H x D)		1155 x 415 x 318	1155 x 415 x 318
	Net / Gross Weight	kg	13.5 / 17.8	13.5 / 17.8
Operating Range	Cooling	°C	16 ~ 32	16 ~ 32
	Heating		0 ~ 30	0 ~ 30
<b>Outdoor Unit Model No.</b>			<b>HONRP70B</b>	<b>HONRP80B</b>
Sound Power Level	dB(A)		65	66.5
Sound Pressure Level @ 1m			61	61
Dimensions	Dimension (W x H x D)	mm	890 x 673 x 342	890 x 673 x 342
	Packing (W x H x D)		995 x 740 x 398	995 x 740 x 398
	Net / Gross Weight	kg	42.4 / 46.9	42.4 / 46.9
Refrigerant	Charged Volume	kg	1.4	1.4
	Pipe Size: Liquid / Gas	mm	6.35mm / 15.9mm	6.35mm / 15.9mm
	Maximum Pipe Length	m	50	50
	Chargeless Length		10	10
	Extra Charge for Lengths >10m	g/m	12	12
	Maximum Vertical Separation	m	25	25
Ambient Temperature Limits	Cooling	°C	-15 ~ 50	-15 ~ 50
	Heating		-15 ~ 24	-15 ~ 4

Capacities tested in accordance with AS/NZS 3823.2, with 5m interconnecting pipe length. With our policy of continuous improvement, we reserve the right to change, or discontinue at any time, specifications or designs without notice.

# NOTES





# Rinnai Australia Pty Ltd

ABN 74 005 138 769 | AU45204

100 Atlantic Drive, Keysborough, Victoria 3173  
P.O. Box 460, Braeside, Victoria 3195  
Tel: (03) 9271 6625

## **National Help Line**

Tel: 1300 555 545\*

*Monday to Friday, 8.00 am to 5.00 pm EST.*

*\*Cost of a local call may be higher from a mobile phone.  
(National calls from public phones in Australia are free.)*

For further information visit **[www.rinnai.com.au](http://www.rinnai.com.au)**  
or email **[enquiry@rinnai.com.au](mailto:enquiry@rinnai.com.au)**

Rinnai has a Service and Spare Parts network with personnel who are fully trained and equipped to give the best service on your Rinnai appliance. If your appliance requires service, please call our National Help Line. Rinnai recommends that this appliance be serviced once a year.

With our policy of continuous improvement, we reserve the right to change, or discontinue at any time, specifications or designs without notice.